

rtc[®]

QUICK CONNECT TECHNOLOGY

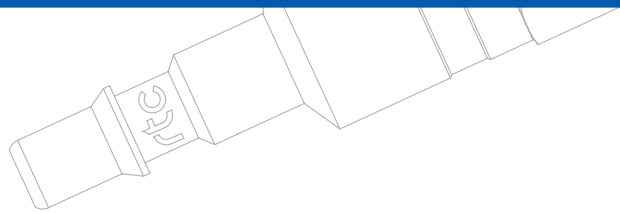

www.rtc-tec.com





rtc-tec Bağlantı Elemanları A.Ş.

As **rtc Coupling**, we are new with **rtc** name but very experienced in knowledge of any kind of fluid line quick connect. That is why, even within start up, we offer satisfaction guarantee on our products. We know, what we are making.

We make big diversity of couplings for water, oil, air..or any kind of fluid at different working conditions (as temperature, pressure..etc), including multi-coupling systems for multiple connection requirements. With a big diversity of our product range, we offer interchangeability for many other competitors products with better pricing and better quality. We also offer custom design depending on customer's needs. Custom design can be a specific product will work in very special working conditions (like very high pressure or very high temperature...etc) or will have some specialties (like being able to engage under pressure...etc) depending on customer needs. We also design special multi-coupling plate systems (Multi-coupling plates can include couplings for water, air, hydraulic or electrical couplers and/or combinations of them at the same time in the same plate) for quick mold change systems.





Right now, we are already exporting 90 % of our products to different 8 countries. We are expanding everyday by offering better quality with affordable pricing.

Als **rtc Coupling** sind wir eine neue Marke am Markt - dahinter steckt ein Expertenteam mit langjähriger Erfahrung im Bereich Kupplungstechnik für alle Arten von Medien. Wir haben höchstes Vertrauen in unsere Produkte - wir wissen was wir tun!

Wir machen große Unterschiede bei Kupplungen für Wasser, Öl, Druckluft oder flüssige Medien bei ihren Einsatzbereichen. Das betrifft Druck, Medientemperatur oder Umfeld - das gilt selbstverständlich auch für Multikupplungen und Kupplungssysteme. Mit einer großen Bandbreite sind wir in der Lage zu vielen Herstellern Alternativen mit einem interessanten Preis-Leistungsverhältnis anzubieten. Gerne entwickeln wir gemeinsam mit unseren Kunden spezielle Produkte für deren Anspruch. Das sind unter anderem Multikupplungssysteme mit Kupplungen für Hydraulik, Flüssigkeiten und Druckluft bei Bedarf auch mit elektrischen Anschlüssen auf einer Sondermultikupplungsplatte.

Aktuell ist der Exportanteil über 90%. Tag für Tag erreichen wir mehr Kunden rund um die Welt mit Premiumprodukten zu marktgerechten Preisen.

Fordern Sie uns heraus.

WATER 
PNEUMATIC 
HYDRAULIC 
ELECTRICAL 
ACCESORIES 

rtc®
 QUICK CONNECT TECHNOLOGY

www.rtc-tec.com

Explanation of rtc type Codes

rtc Type Codes

Plate Type	Type	DN (Flow Diameter)	Part Type	Connect Type	Valve Type	Mounting Type	Thread Type	Other Addition
K Fixed	450	03	S Socket	M Male	B Both Side	P Panel Mounted	10 1/8"	N NBR
M Mobile	451	04	P Plug	F Female	O One Side	D Two Coupler On the Panel	13 1/4"	V FPM
	452	05		P Push - Lock	F Free	S Self Venting	17 3/8"	E EPDM
	460	06		H Hose		K Plastic	21 1/2"	T PTFE
	461	07		R BSPT Male		E Safety (Push Plug)	26 3/4"	W FFKM
	462	08		Q BSPT Female		H Inner Hexagonal	33 1"	VI FKM
	463	08		N NPT Female		G Spring Guard	42 1-1/4"	PT PTFE Seal
	464	09		T NPT Male			48 1-1/2"	MS Messing
	465	10		U UNF			60 2"	ST Steel
	466	11		J JIC Norm			75 2-1/2"	S3 Stainless Steel AISI 303
	467	12		A Assembled			88 3"	S6 Stainless Steel AISI 316
	468	15		E Extention			1010 M10x1	SS Stainless Steel
		16		K Conical Metric Thread			1015 M10x1.5	AL Aluminium
		19		D Dust Cup			1215 M12x1.5	PS Plastic Material
		10		V Plastic Hose			1415 M14x1.5	CH Chrom
		11		L Pressure Cup			1615 M16x1.5	KN Chemical Nickel
		12		Z NPSF Male			13-74 UNF 1/2"-74°	NI Vernickelt
		15		S NPSF Female			17-60 3/8° - 60°	B Blue
		16		Y Plastic Hose (With Spring)			1615-10 M16x1.5 Ø10	R Red
		19					2615-18 M26x1.5 Ø18	F Grey
								G Green
								S Black
								Y Yellow
								BF Brass Free
								SF Silicone Free
								P Pressure Balancer
								LP Low Pressure
								MD Medium Pressure
								HP High Pressure
								HT High Temperature
								VA Vacuum
								VP Safety Sleeve
								SI Additional Axial Safety Lock
								HB High Button
								KO Angled Code
								LP Locking Screw
								LN Locking Nut
								KV Short Version
								LT Long Thread
								KS O-Ring & Washer
								60 DIN 7631
								90 90° Connection
								135 135° Connection
								PL Pressure Cup For Plug
								SL Pressure Cup For Socket
								PD Plug Dust Cup
								SD Socket Dust Cup
								C Manifold with Collector
								OP Only Plate
								EX Special (Extra)

Index

Type Codes	PAGE
Explanation of rtc type Codes	2
Seals And Coupling Materials Using Table	4 - 5
Hose Connection Types	6
Symbols	7
rtc type SV - Rotary Sleeve Couplers	8 - 9
rtc type 450.03 / SV 1-Stage	10 - 13
rtc type 450.06 / SV 2-Stage	14 - 17
rtc type 450.08 / SV 2-Stage	18 - 21
rtc type 450.11 / SV 2-Stage	22 - 26
rtc type 451.06 / SV 2-Stage	28 - 31
rtc type 451.08 / SV 2-Stage	32 - 35
rtc type 452.06 / SV 2-Stage Coded	36 - 45
rtc type SC - Swing Couplers	46 - 47
rtc type 460.06 / SC-B1	48 - 51
rtc type 460.08 / SC-E	52 - 55
rtc type 460.11 / SC-H&HB	56 - 59
rtc type 461.06 / SC-K	60 - 63
rtc type 461.08 / SC-E1	64 - 67
rtc type 461.11 / SC-G	68 - 71
rtc type 461.19 / SC-I	72 - 75
rtc type 462.06 / SC-A1	76 - 79
rtc type 463.08 / SC-C	80 - 83
rtc type 464.08 / SC-D&DL	84 - 87
rtc type 465.08 / SC-M	88 - 91
rtc type 466.06 / SC-P	92 - 95
rtc type 467.06 / SC-N	96 - 99
rtc type 468.08	100 - 103
rtc type Accessories	104

NBR (Nitrile)	FPM (Viton)	EPDM	PTFE (Teflon)
<p>Main properties: Resistant to oil and petrol good ageing characteristics, high abrasion resistance.</p> <p>Als Dichtungswerkstoffe stehen folgende Serlenqualitäten zur Verfügung: Perbunan, Haupteigenschaften: Beständigkeit gegen Öl und Benzin gute Alterungsbeständigkeit, hoher Schutz gegen Abrieb.</p>	<p>Main properties: Outstanding heat resistant performance, excellent resistance to oils, chemicals, solvent, active oxygen, and weather.</p> <p>Viton, Haupteigenschaften: Übertreffende Hitzebeständigkeit, ausgezeichnete Beständigkeit gegen Öle, Chemikalien, Lösungsmittel, Ozon, Sauerstoff und Witterung.</p>	<p>Main properties Ethylen Propylen, High mechanical strength, excellent resistance to high and low temperatures and to active oxygen and weather. Good resistance to chemical media.</p> <p>EP, Äthylen Propylen, Haupteigenschaften: Hohe mechanische Festigkeit. Ausgezeichnete Wärme- und Kältebeständigkeit. Hervorragende Beständigkeit gegen Ozon- und Witterungseinflüsse. Gute chemische Beständigkeit.</p>	<p>For very aggressive media special constructions with PTFE seals (Teflon) are available. Für sehr aggressive Medien sind Sonderkopplungen mit PTFE-Dichtungen (Teflon) verfügbar. Alle Angaben sind unverbindlich und dienen nur zur Orientierung. Sie gelten 1. für reine Stoffe, 2. wenn nicht anders angegeben für Flaumtemperatur. 3. bei Säuren, Säuren usw. für wässrige Lösungen mäßiger Konzentrationen. Teflon-eingetragenes 'Dupont'-Warenzeichen.</p>

Symbols - Korrosionstabelle	Material						Seal Dichtung		
	Steel zinc plated Stahl Verzinkt	Brass - Messing	AISI 316 Ti or similar Edelstahl AISI 316 Ti	Polyamide 11/12	Polyacetel - Poliasetel	NBR Nitrile	FPM Viton	EPDM	
<p>✓ Fully resistant / beständig</p> <p>D Partly resistant / bedingt</p> <p>— Non-resistant / nicht</p>									
Acetate (Ethyl Acetate & Amyl Acetate)	✓	✓	✓	✓	✓			X	
Acetic acid 10%		—	✓	—	✓			X	
Acetone	✓	✓	✓	✓	✓			X	
Acetylene	✓	✓	✓	✓	✓	X	X	X	
Aero Engine Fuel BP, Esso Avgas100/130	✓	✓	✓	✓	D	X	X		
Aero Engine Oil BP: AIRO 1210, Esso AVIATON-120 Shell: AIRO-120, DERD 2487 DERD 2497, DTD 585	✓	✓	✓	✓	D	X	X		
Skydrol	✓	—	✓	—	—			X	
Oronite	✓	—	✓	—	—		X		
Air, compressed	✓	✓	✓	✓	✓	X	X		
Air, hot up to 120°C	✓	✓	✓	D			X	X	
Air, hot up to 200°C	✓	✓	✓	—	—		X		
Alcohol	✓	✓	✓	✓	✓		X		
Alum		—	✓	✓	✓	X	X	X	
Alkalies	—	D	✓	✓	D	X		X	
Ammonia, Liquid	D	—	✓	✓	—			X	
Ammonium Sulphate Solution	—	—	✓	✓	D	X	X	X	
Amyl Alcohol	✓	✓	✓	✓	✓		X		
Aniline	✓	—	✓	D			X		
Benzole	✓	✓	✓	✓	✓		X		
Borax	✓	✓	✓				X	X	
Bultane	✓	✓	✓	✓	✓	X	X		
Bultane	✓		✓			X	X		
Butyl Alcohol	—	✓	✓	✓	✓			X	
Carbon Dioxide	—	✓	✓	✓	✓	X	X	X	
Carbon Dioxide, dry		✓	✓	✓		X	X	X	
Carbon Dioxide liquid	—	✓	✓	✓	D	X	X	X	
Carbon Bisulphide	✓		✓				X		
Chloride of Barium		✓	D	✓	✓	X	X	X	
Chromic Acid	—	—	D	D	—		X		
Citric Acid	—	D	✓	—	D		X	X	
Creosote	✓		✓				X		
Cresol	D	✓	✓	—	—		X		
Cresol, Cresylic Acid	✓		✓				X		
Cupric Chloride	✓		D	—		X	X	X	
Cyclohexane	✓		✓	D	✓		X		
Dimethylamine	✓		✓				X		
Emulsion. (Water/Oil)	D	✓	✓	✓	✓	X	X		
Ether	✓	✓	✓	✓	✓		X		

Symbols - Korrosionstabelle	Material						Seal Dichtung		
	Steel zinc plated Stahl Verzinkt	Brass - Messing	AISI 316 Ti or similar Edelstahl AISI 316 Ti	Polyamide 11/12	Polyacetel - Poliasetel	NBR Nitrile	FPM Viton	EPDM	
<p>✓ Fully resistant / beständig</p> <p>D Partly resistant / bedingt</p> <p>— Non-resistant / nicht</p>									
Ethyl Alcohol	✓		✓	✓	✓	X		X	
Ethylene	✓	✓	✓	✓	✓		X		
Formalin	✓	✓	✓			D	X	X	
Formic Acid	—	D	✓	—	—			X	
Frigen	✓	✓	✓	✓	✓	X	X		
Gasoline, Refined	✓		✓			X	X		
Gas, Blast Furnace	D	✓	✓	—	D		X		
Gas, Coal	D	✓	✓	✓	✓		X		
Gas, Coke Oven	D	✓	✓	D	D	X			
Gas, Lighting	✓	✓	✓	✓	✓	X	X		
Gas, Naphtalene content	✓	✓	✓	✓	✓	D	X	X	
Gas, Natural	✓	✓	✓	✓	✓	X	X		
Gas, Town	✓	✓	✓	✓	✓	X			
Gear Oil	✓		✓	✓	✓	X	X		
Glucose		✓	✓	✓	✓	X	X	X	
Glycerine	✓	✓	✓	✓	✓	X	X	X	
Glycol	✓	✓	✓	✓	✓	X		X	
Helium	✓	✓	✓	✓	✓	X	X	X	
Hexane	✓		✓	✓	D	X	X		
Hydrocarbons	✓	✓	✓	✓	✓	X	X		
Hydrogen	✓	✓	✓	✓	D	X	X		
Hydrogen Gas	✓		✓			X	X		
Hydrogen Sulphide, Humid		D	✓	✓				X	
Hydrogen Sulphide, dry		✓	✓		✓			X	
Hydrogen Peroxide 30%	—	—	✓	✓			X		
Isopropyl Alcohol	✓		✓	D	✓	X	X	X	
Kerosene, JP 1	✓	✓	✓	✓	✓	X	X		
Keton, Methyl Ethyl	✓	✓	✓	✓	✓			X	
Latex, liquid up to 130°C	✓	✓	✓	D	D	X			
Lubricating Oil	✓	✓	✓	✓	✓	X	X		
Lye, Caustic	—	✓	✓	✓	D			X	
Lye, Hyochorous Acid	—		✓	—	D				
Lye, Pickling	—	MS60	✓	D	D		X		
Magnesium Carbonate	✓		✓	✓	✓	X	X	X	
Magnesium Hydroxide	✓	✓	✓	✓	✓	X	X	X	
Magnesium Sulphate. M.Sulfat		—	✓	✓	✓	X	X	X	
Mercury	✓	—	✓	✓	✓	X	X	X	
Methane	✓	✓	✓	✓	✓	X	X		
Methanol	✓	✓	✓	✓	✓	X		X	
Methyl Alcohol	✓	✓	✓	D	✓	X		X	
Methyl Ethyl Ketone	✓		✓	✓	✓			X	

NBR (Nitrile)	FPM (Viton)	EPDM	PTFE (Teflon)
<p>Main properties: Resistant to oil and petrol good ageing characteristics, high abrasion resistance.</p> <p>Als Dichtungswerkstoffe stehen folgende Serlenqualitäten zur Verfügung: Perbunan, Haupteigenschaften: Beständigkeit gegen Öl und Benzin gute Alterungsbeständigkeit, hoher Schutz gegen Abrieb.</p>	<p>Main properties: Outstanding heat resistant performance, excellent resistance to oils, chemicals, solvent, active oxygen, and weather.</p> <p>Viton, Haupteigenschaften: Überragende Hitzebeständigkeit, ausgezeichnete Beständigkeit gegen Öle, Chemikalien, Lösungsmittel, Ozon, Sauerstoff und Witterung.</p>	<p>Main properties Ethylen Propylene, High mechanical strength, excellent resistance to high and low temperatures and to active oxygen and weather. Good resistance to chemical media.</p> <p>EP, Athylen Propylen, Haupteigenschaften: Hohe mechanische Festigkeit. Ausgezeichnete Wärme- und Kältebeständigkeit. Hervorragende Beständigkeit gegen Ozon- und Witterungseinflüsse. Gute chemische Beständigkeit.</p>	<p>For very aggressive media special constructions with PTFE seals (Teflon) are available. Für sehr aggressive Medien sind Sonderkupplungen mit PTFE-Dichtungen (Teflon) verfügbar. Alle Angaben sind unverbindlich und dienen nur zur Orientierung. Sie gelten 1. für reine Stoffe, 2. wenn nicht anders angegeben für Raumtemperatur. 3. bei Säuren, Säuren usw. für wässrige Lösungen mäßiger Konzentrationen. Teflon-eingetragenes Dupont-Warenzeichen.</p>

Symbols - Korrosionstabelle	Material					Seal Dichtung		
	Steel zinc plated Stahl Verzinkt	Brass - Messing	AISI 316 Ti or similar Edelstahl AISI 316 Ti	Polyamide 11/12	Polyacetel - Poliasetel	NBR Nitrile	FPM Viton	EPDM
<p>✓ Fully resistant / beständig</p> <p>D Partly resistant / bedingt</p> <p>— Non-resistant / nicht</p>								
Methyl Benzene	✓		✓				X	
Milk	✓	—	✓	✓	✓	X		X
Napta	✓		✓	✓	✓	X	X	
Naptalene	✓	✓	✓	✓	✓		X	
Naptenic. Acid	✓		✓			X	X	
Nitrate of Ammonium	✓		✓			X	X	X
Nitric Acid. up to 35°C	—	✓	✓	—	—		X	
Nitrogen	✓	✓	✓	✓	✓	X	X	X
Nitro-Solution (no synthetic resin thinners)	✓	✓	✓	—	✓			X
Oil, Coal Tr	✓		✓	✓	D		X	
Oil, Crude	✓	✓	✓	✓	✓	X	X	
Oil, Diesel	✓	✓	✓	✓	✓	X		
Oil, Diesel up to 120°C		✓	✓	D	—		X	
Oil, Fuel up to 100°C	✓	✓	✓	D	—	X	X	
Oil, up to 200°C/ 300°C up to (special type)	✓	D	✓	—	—		FFKM	
Oil, Fuel 5x5	✓	✓	✓	D	✓		X	
Oil, Hydraulic Chlorinated	D	D	✓	—	D		X	
Oil, Hydraulic up to 120°C	✓	✓	✓	D	D	X	X	
Oil, Linseed	✓	✓	✓	✓	✓	X	X	
Oil, Mineral	D	✓	✓	✓	✓	X	X	
Oil, Transformer	D	D	✓	✓	D	X		
Oleic Acid	✓	—	✓	✓	✓	X	X	
Oxalic Acid	D	D	✓	✓	✓		X	X
Oxygen. fat free	—	✓	✓	✓	D			X
Paraffin	✓	✓	✓	✓	✓	X		
Paraffin, (Wax)	✓	✓	✓	✓	✓	X		
Pentachlorophenole	✓						X	
Petrol Ether		✓	✓	✓	✓	X		
Petrol	✓	✓	✓	✓	✓	X		
Phenol Solution	D	✓	✓	—	—			
Phosphoric Acid 10%			✓	—	—		X	X
Potassium Cyanide	✓	—	✓	✓	D		X	X
Potassium Dichromate	✓	—	✓	—	D		X	X
Potassium Sulphate	✓		✓			X	X	X
Potassium Hydroxide	✓		✓	✓	D			X
Propane	✓	✓	✓	✓	✓	X	X	
Prussic Acid	✓	—	✓				X	
Salt Solution	—	D	D	✓	D		X	X
Sea Water		—	D		✓	X	X	X

Symbols - Korrosionstabelle	Material					Seal Dichtung		
	Steel zinc plated Stahl Verzinkt	Brass - Messing	AISI 316 Ti or similar Edelstahl AISI 316 Ti	Polyamide 11/12	Polyacetel - Poliasetel	NBR Nitrile	FPM Viton	EPDM
<p>✓ Fully resistant / beständig</p> <p>D Partly resistant / bedingt</p> <p>— Non-resistant / nicht</p>								
Soap Solution	—	✓	✓	✓	✓	X	X	X
Soap Solution	—	D	✓	✓	D	X	X	X
Sodium Acetate			✓	✓	✓	X		X
Sodium Bicarbonate			D	✓	✓		X	X
Sodium Carbonate	✓		✓	✓	✓	X	X	X
Sodium Chloride	✓		✓	✓	✓	X	X	X
Sodium Cyanide	✓		✓	—	D			X
Sodium Sulphide	✓	D	✓				X	X
Steam, up to 150°C	D	D	✓	—	—			X
Steam, up to 250°C	D	D	✓	—	—			PTFE
Sulphide of barium	✓	D	✓	✓		X	X	X
Sulphur Dixide, Gas		✓	✓					X
Sulphuret of Carbon		✓	✓	—	✓			X
Syntetic Resin Thinners (no nitrosolution)	✓	✓	✓	D	D			X
Tar	✓	✓	✓	✓	✓	X	X	
Tetrachloride of Titanium	✓		✓					X
Toluol, dry	D	✓	✓	✓	✓			X
Trichlorethylene	✓	D	✓	✓	—			X
Turbine Fuel, BP: ATK 2494, ES-SO:MIL-F56/16, SHELL:ATF 650	✓	✓	✓	✓	D	X	X	
Turbine Oil, Esso:35	✓	✓	✓	✓	D	X	X	
Turb-oil 1 S (MILL 7808)	D	D	✓	✓	D	X	X	
Vacuum (Strengthened Valve Springs)	✓	✓	✓	✓	✓			
Vegetable Oil	✓		✓	✓	✓	X	X	X
Water, Distilled			✓	✓	✓			X
Water, Deionized			✓			X	X	
Water, Demineralised			✓					X
Water, up to 80°C	D	✓	✓	D	D	X	X	X
Water, over 80°C	D	✓	✓	D	—			X
Water, Cooling	D	D	✓	✓	D			X
Xylene	✓	✓	✓	✓	✓			X



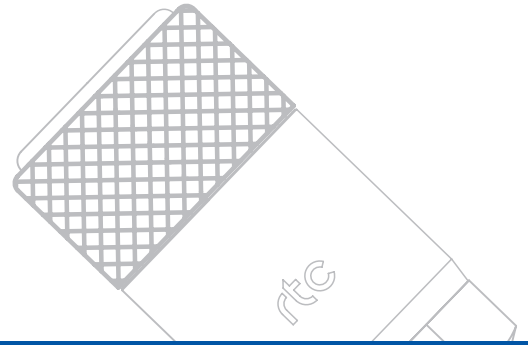
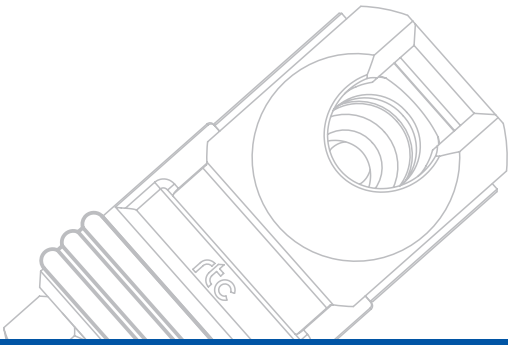

rtc type SV & SC



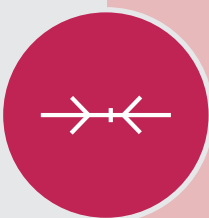
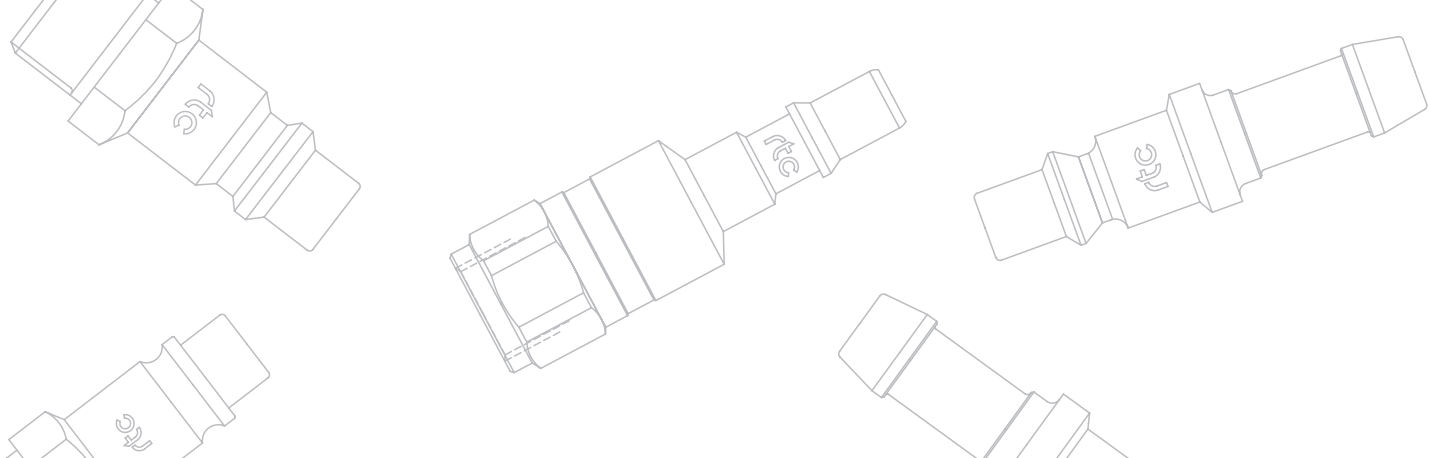

Straight-Through

These coupling systems work with no shut-off valve, which means they can achieve the greatest possible flow. Further, turbulence which can occur with integrated valves is completely eradicated. Straight-through couplings are ideally suited to liquid media – e.g. water applications. Before unlocking, the flow must be stopped.



Single Shut-Off

On our single shut-off systems, the plug is designed straight-through – although the coupling shuts off immediately when the connection is broken. Appearance of on-flow media in the line is effectively prevented. An ideal solution for operating compressed air tools.



Double Shut-Off

On our double shut-off systems, after disconnection, the flow stops both in the coupling and in the plug. The medium remains in the hose in both connecting lines, the pressure is held constant and not released.



rtc[®]

QUICK CONNECT TECHNOLOGY
www.rtc-tec.com

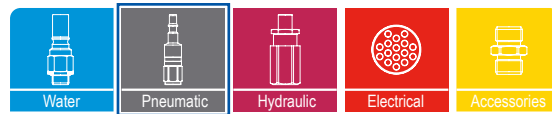

SV rtc TYPE





Temperature Range - Temperaturbereich

Nitrile (N)	-20°C + 110°C (-4°F + 230°F)
FPM (V)	-20°C + 180°C (-4°F + 356°F)
EPDM (Ethylene Propylene)	-40°C + 150°C (-40°F + 302°F)

Working Pressure - Betriebsdruck

25 Bar (360 PSI)

Connction/Disconnection Pressure -

15 Bar (220 PSI)

Material of steel version / Material für die Stahl Version

Socket Body - Kupplungsgrundkörper	Steel tenifer threaded Stahl teneriert
Back Part - Hinterteil	Steel zinc-nickel plated Stahl Zink-Nickel beschichtet
Sleeve - Hülse	Steel zinc-nickel plated and orange painted Stahl Zink-Nickel beschichtet und orange Lackiert
Springs - Federn	Stainless steel - Edelstahl
Seals - Dichtungen	Nitrile (N)
Plug - Nippel	Steel tenifer threaded Stahl teneriert

rtc type 451 The sleeve orange colour plastic
Hülse ist aus Kunststoff, farbe orange

Material of stainless the steel version

Material für die Edelstahlversion

Socket Body - Kupplungsgrundkörper	Stainless steel Edelstahl
Back Part - Hinterteil	Stainless steel - Edelstahl
Sleeve - Hülse	Stainless steel - Edelstahl
Springs - Federn	Stainless steel - Edelstahl
Seals - Dichtungen	FPM (V)
Plug - Nippel	Stainless steel - Edelstahl

Advantages

- The system perfectly fits to the **ISO 4414, EN 983** safety requirements.
- Plug profile perfectly fits to the **ISO 6150-C & AFNOR-C**
- 2 stage disconnection safety feature
- Negligible Connecting Force
- Smart and Ergonomic features
- Ease of Handling
- Optimised Size

Vorteil

- Sicherheit gemäß **ISO 4414, EN 983**
- Stecknippel gemäß **ISO 6150-C & AFNOR-C**
- 2 stufen Sicherheitsentriegelung
- Einfache Bedienung, sehr geringe Kuppelkraft
- Kompakte Bauform

Working Principle

- Connection

Push plug into coupling until it is heard to engage by a click by one-hand.

- Disconnection

The plug is disconnected by turning the release ring to left. It is held back by the safety catch, until the air hose is ventilated. The plug can only be released by turning the release ring to the right.

Arbeitsprinzip

- Einkuppeln

Nippel in die Kupplung eindrücken bis der Nippel hörbar einrastet - auch mit einer Hand möglich.

- Entkuppeln

Durch eine Linksdrehung der Drehhülse wird der Nippel ausgekuppelt, jedoch von der Sicherheitsklinke erst freigegeben wenn der Druckluftschlauch entlüftet ist. Erst nach Rechtsdrehung der Drehhülse wird der Stecknippel freigegeben.

Flow size - Nennweiten

rtc type 450.03 / SV 1-Stage	3mm (1/8")
rtc type 450.06 / SV 2-Stage	5.5mm (1/4")
rtc type 450.08 / SV 2-Stage	8mm (3/8")
rtc type 450.11 / SV 2-Stage	11mm (1/2")
rtc type 451.06 / SV 2-Stage	5.5mm (1/4")
rtc type 451.08 / SV 2-Stage	8mm (3/8")
rtc type 452.06 / SV Coded	5.5mm (1/4")

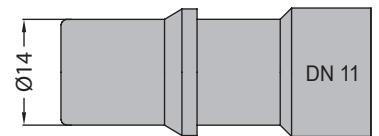
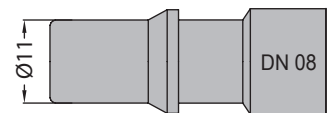
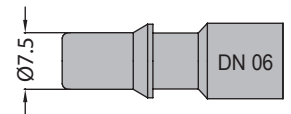
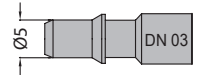

Flow Rate vs Pressure Drop Graph

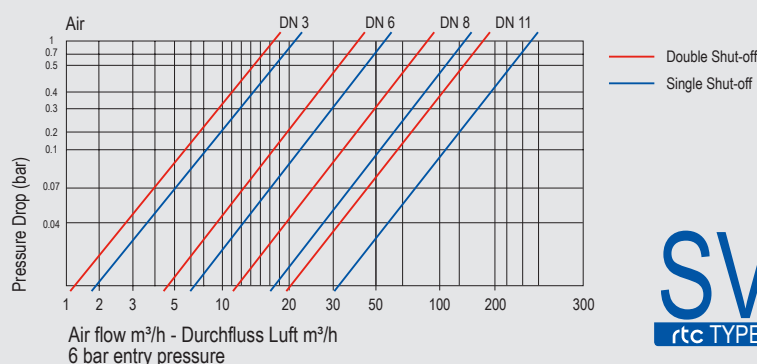



rtc[®]

QUICK CONNECT TECHNOLOGY
www.rtc-tec.com

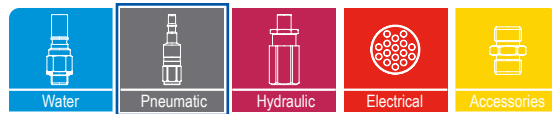

450.03

rtc TYPE





Compatible - Kompatibilität

rtc 170.03
rtc 173.03

Temperature Range - Temperaturbereich

Nitrile (N) -20°C + 110°C (- 4°F + 230°F)
FPM (V) -20°C + 180°C (- 4°F + 356°F)
EPDM (Ethylene Propylene) -40°C + 150°C (- 40°F + 302°F)

Working Pressure - Betriebsdruck

25 Bar (360 PSI)

Connction / Disconnection Max. Pressure -

Ein- und Auskuppelbar bis Max. Druck
15 Bar (220 PSI)

Flow size - Nennweite

rtc type 450.03 3mm (1/8")

Standard version - Standardversion

Seals - Dichtung : Nitrile (N)

Material of steel version / Material für die Stahl Version

Socket Body - Kupplungsgrundkörper	Steel tenifer threaded Stahl teneferiert
Back Part - Hinterteil	Steel zinc-nickel plated Stahl Zink-Nickel beschichtet
Sleeve - Hülse	Steel zink-nickel plated Stahl Zink-Nickel beschichtet und orange Lackiert
Springs - Federn	Stainless steel - Edelstahl
Seals - Dichtungen	Nitrile (N)
Plug - Nippel	Steel tenifer threaded Stahl teneferiert

Advantages

- Plug profile perfectly fits to the ISO 6150-C-8, AFNOR C-8 NF E 49-053
- Negligible Connecting Force
- Smart and Ergonomic features
- Ease of Handling
- Optimised Size

Vorteil

- Stecknippel gemäß ISO 6150-C-8, AFNOR C-8 NF E 49-053
- Einfache Bedienung, sehr geringe Kuppelkraft
- Kompakte Bauform

Material of stainless the steel version

Material für die Edelstahlversion

Socket Body - Kupplungsgrundkörper	Stainless steel Edelstahl
Back Part - Hinterteil	Stainless steel - Edelstahl
Sleeve - Hülse	Stainless steel - Edelstahl
Springs - Federn	Stainless steel - Edelstahl
Seals - Dichtungen	FPM (V)
Plug - Nippel	Stainless steel - Edelstahl



Flow Rate vs Pressure Drop Graph

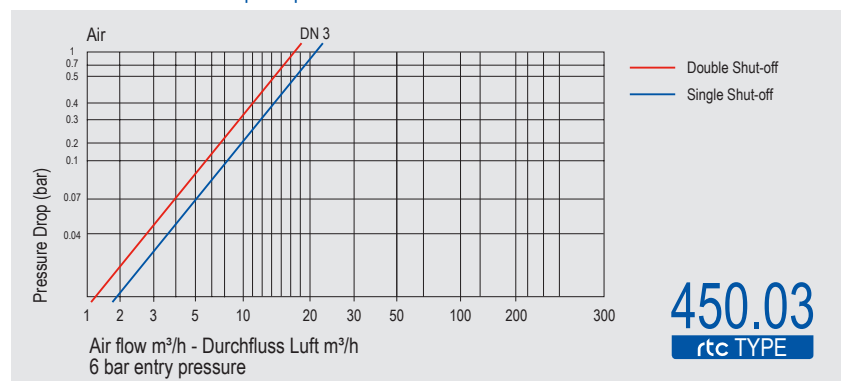

rtc TYPE 450.03 Metal sleeve socket with male thread / Kupplung mit Metallhülse und Aussengewinde  

Socket / Kupplung

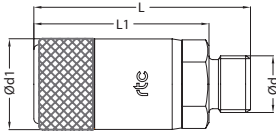

*SS: Stainless Steel / Edelstahl

Size / Größe	Alternative Order No Alternative Bestellnr.	Order No / Bestellnr.	Ød	Ød1	L	L1	HEX.
3	-	450.03 SMB 10	BSP 1/8	17	42.5	34.5	14
3	-	450.03 SMB 13	BSP 1/4	17	44.5	34.5	14
3	-	450.03 STB 10	NPT 1/8	17	43.5	34.5	14
3	R303 00 582	450.03 SMB 10 SS	BSP 1/8	17	42.5	34.5	14
3	R303 00 583	450.03 SMB 13 SS	BSP 1/4	17	44.5	34.5	14
3	R303 00 584	450.03 STB 10 SS	NPT 1/8	17	43.5	34.5	14

rtc TYPE 450.03 Metal sleeve socket with female thread / Kupplung mit Metallhülse und Innengewinde  

Socket / Kupplung

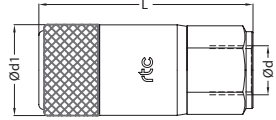

*SS: Stainless Steel / Edelstahl

Size / Größe	Alternative Order No Alternative Bestellnr.	Order No / Bestellnr.	Ød	Ød1	L	L1	HEX.
3	-	450.03 SFB 10	BSP 1/8	17	39	-	14
3	-	450.03 SNB 10	NPT 1/8	17	39	-	14
3	R303 00 580	450.03 SFB 10 SS	BSP 1/8	17	39	-	14
3	R303 00 581	450.03 SNB 10 SS	NPT 1/8	17	39	-	14

rtc TYPE 450.03 Metal sleeve standard hose socket / Kupplung mit Metallhülse und Schlauchanschluss  

Socket / Kupplung

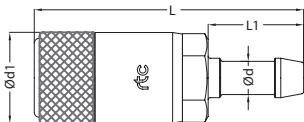

*SS: Stainless Steel / Edelstahl

Size / Größe	Alternative Order No Alternative Bestellnr.	Order No / Bestellnr.	Ød	Ød1	L	L1	HEX.
3	-	450.03 SHB 04	Ø4 - 3/16	17	46	13	-
3	-	450.03 SHB 06	Ø6 - 1/4	17	46	13	-
3	-	450.03 SHB 08	Ø8 - 5/16	17	46	13	-
3	R303 00 585	450.03 SHB 04 SS	Ø4 - 3/16	17	46	13	-
3	R303 00 586	450.03 SHB 06 SS	Ø6 - 1/4	17	46	13	-
3	R303 00 587	450.03 SHB 08 SS	Ø8 - 5/16	17	46	13	-

rtc TYPE 450.03 Male thread plug / Nippel mit Aussengewinde 

Plug / Nippel

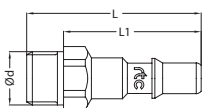

*SS: Stainless Steel / Edelstahl

Size / Größe	Alternative Order No Alternative Bestellnr.	Order No / Bestellnr.	Ød	Ød1	L	L1	HEX.
3	-	461.03 PMF 10	BSP 1/8	-	36.5	28.5	14
3	-	461.03 PTF 10	NPT 1/8	-	37.5	28.5	14
3	R355 00 274	461.03 PMF 10 SS	BSP 1/8	-	36.5	28.5	14
3	R355 00 338	461.03 PTF 10 SS	NPT 1/8	-	37.5	28.5	14

Female thread plug / Nippel mit Innengewinde TYPE 450.03 **rtc**

Plug / Nippel	Size / Größe	Alternative Order No Alternative Bestellnr.	Order No / Bestellnr.	Ød	Ød1	L	L1	HEX.
	3	-	461.03 PFF 10	BSP 1/8	-	35	-	13
	3	-	461.03 PNF 10	NPT 1/8	-	35	-	13
	3	R355 00 273	461.03 PFF 10 SS	BSP 1/8	-	35	-	13
	3	R355 00 339	461.03 PNF 10 SS	NPT 1/8	-	35	-	13

*SS: Stainless Steel / Edelstahl

Standard hose plug / Nippel mit Schlauchanschluss TYPE 450.03 **rtc**

Plug / Nippel	Size / Größe	Alternative Order No Alternative Bestellnr.	Order No / Bestellnr.	Ød	Ød1	L	L1	HEX.
	3	-	461.03 PHF 04	Ø4 - 5/32	10	39.5	13	-
	3	-	461.03 PHF 06	Ø6 - 1/4	10	39.5	13	-
	3	R355 00 276	461.03 PHF 04 SS	Ø4 - 5/32	10	39.5	13	-
	3	R355 00 277	461.03 PHF 06 SS	Ø6 - 1/4	10	39.5	13	-

*SS: Stainless Steel / Edelstahl

Male thread plug with valve / Verschlussnippel mit Aussengewinde TYPE 450.03 **rtc**

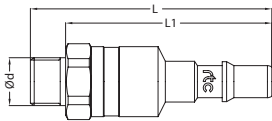
Plug / Nippel	Size / Größe	Alternative Order No Alternative Bestellnr.	Order No / Bestellnr.	Ød	Ød1	L	L1	HEX.
	3	-	461.03 PMB 10	BSP 1/8	-	49.5	41.5	14
	3	-	461.03 PTB 10	NPT 1/8	-	50.5	41.5	14
	3	-	461.03 PMB 10 SS	BSP 1/8	-	49.5	41.5	14
	3	-	461.03 PTB 10 SS	NPT 1/8	-	50.5	41.5	14

*SS: Stainless Steel / Edelstahl

Female thread plug with valve / Verschlussnippel mit Innengewinde TYPE 450.03 **rtc**

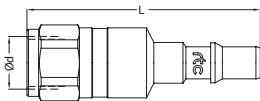
Plug / Nippel	Size / Größe	Alternative Order No Alternative Bestellnr.	Order No / Bestellnr.	Ød	Ød1	L	L1	HEX.
	3	-	461.03 PFB 10	BSP 1/8	-	50.5	-	14
	3	-	461.03 PNB 10	NPT 1/8	-	50.5	-	14
	3	-	461.03 PFB 10 SS	BSP 1/8	-	50.5	-	14
	3	-	461.03 PNB 10 SS	NPT 1/8	-	50.5	-	14

*SS: Stainless Steel / Edelstahl

Standard hose plug with valve / Verschlussnippel mit Schlauchanschluss TYPE 450.03 **rtc**

Plug / Nippel	Size / Größe	Alternative Order No Alternative Bestellnr.	Order No / Bestellnr.	Ød	Ød1	L	L1	HEX.
	3	-	461.03 PHB 04	Ø4 - 5/32	-	54.5	13	-
	3	-	461.03 PHB 06	Ø6 - 1/4	-	54.5	13	-
	3	-	461.03 PHB 04 SS	Ø4 - 5/32	-	54.5	13	-
	3	-	461.03 PHB 06 SS	Ø6 - 1/4	-	54.5	13	-

*SS: Stainless Steel / Edelstahl



rtc[®]

QUICK CONNECT TECHNOLOGY
www.rtc-tec.com

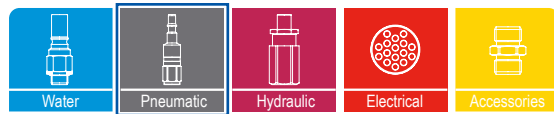

450.06

rtc TYPE





Compatible - Kompatibilität

rtc	170.06
rtc	171.06
rtc	173.06
rtc	451.06
rtc	461.06 / SC-K

Temperature Range - Temperaturbereich

Nitrile (N)	-20°C + 110°C (- 4°F + 230°F)
FPM (V)	-20°C + 180°C (- 4°F + 356°F)
EPDM (Ethylene Propylene)	-40°C + 150°C (- 40°F + 302°F)

Working Pressure - Betriebsdruck

25 Bar (360 PSI)

Connction / Disconnection Max. Pressure -

Ein- und Auskuppelbar bis Max. Druck

15 Bar (220 PSI)

Flow size - Nennweite

rtc type 450.06 5.5mm (1/4")

Standard version - Standardversion

Seals - Dichtung : Nitrile (N)

Material of steel version / Material für die Stahl Version

Socket Body - Kupplungsgrundkörper	Steel tenifer threaded Stahl teneferiert
Back Part - Hinterteil	Steel zinc-nickel plated Stahl Zink-Nickel beschichtet
Sleeve - Hülse	Steel zinc-nickel plated and orange painted Stahl Zink-Nickel beschichtet und orange lackiert
Springs - Federn	Stainless steel - Edelstahl
Seals - Dichtungen	Nitrile (N)
Plug - Nippel	Steel Tenifer Threaded Stahl Teneferiert

Advantages

- The system perfectly fits to the **ISO 4414, EN 983** safety requirements.
- Plug profile perfectly fits to the **ISO 6150-C-10, AFNOR C-10 NF E 49-053**
- 2 stage disconnection safety feature
- Negligible Connecting Force
- Smart and Ergonomic features
- Ease of Handling
- Optimised Size

Vorteil

- Sicherheit gemäß **ISO 4414, EN 983**
- Stecknippel gemäß **ISO 6150-C-10, AFNOR C-10 NF E 49-053**
- 2 stufen Sicherheitsentriegelung
- Einfache Bedienung, sehr geringe Kuppelkraft
- Kompakte Bauform

Material of stainless the steel version

Material für die Edelstahlversion

Socket Body - Kupplungsgrundkörper	Stainless steel Edelstahl
Back Part - Hinterteil	Stainless steel - Edelstahl
Sleeve - Hülse	Stainless steel - Edelstahl
Springs - Federn	Stainless steel - Edelstahl
Seals - Dichtungen	FPM (V)
Plug - Nippel	Stainless steel - Edelstahl



Flow Rate vs Pressure Drop Graph

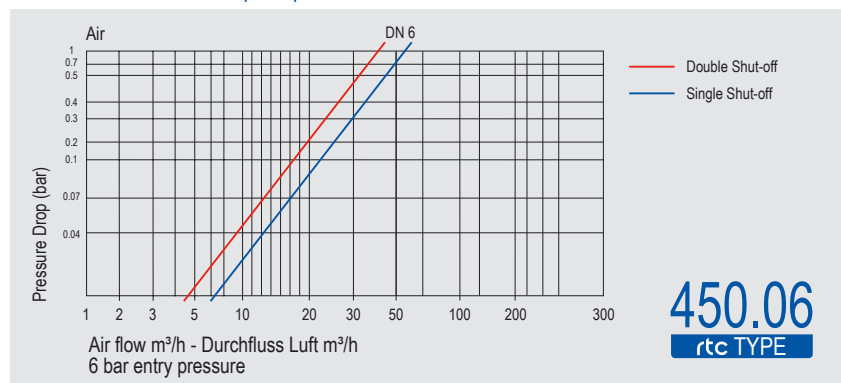

rtc TYPE 450.06

Metal sleeve socket with male thread / Kupplung mit Metallhülse und Aussengewinde



Socket / Kupplung

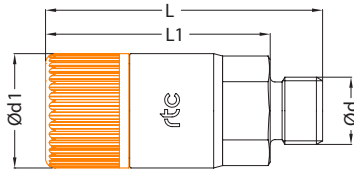

Size / Größe	Alternative Order No Alternative Bestellnr.	Order No / Bestellnr.	Ød	Ød1	L	L1	HEX.
6	R203 00 197	450.06 SMB 13	BSP 1/4	24	55.5	45.5	20
6	R203 00 195	450.06 SMB 17	BSP 3/8	24	55.5	45.5	20
6	R203 00 196	450.06 SMB 21	BSP 1/2	24	57.5	45.5	22
6	-	450.06 STB 13	NPT 1/4	24	57.5	45.5	20
6	-	450.06 STB 17	NPT 3/8	24	57.5	45.5	20
6	R303 00 592	450.06 SMB 13 SS	BSP 1/4	24	55.5	45.5	20
6	R303 00 593	450.06 SMB 17 SS	BSP 3/8	24	55.5	45.5	20
6	R303 00 594	450.06 SMB 21 SS	BSP 1/2	24	57.5	45.5	22
6	R303 00 601	450.06 STB 13 SS	NPT 1/4	24	57.5	45.5	20
6	R303 00 602	450.06 STB 17 SS	NPT 3/8	24	57.5	45.5	20

*SS: Stainless Steel / Edelstahl

rtc TYPE 450.06

Metal sleeve socket with female thread / Kupplung mit Metallhülse und Innengewinde



Socket / Kupplung

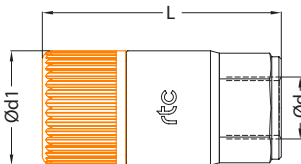

Size / Größe	Alternative Order No Alternative Bestellnr.	Order No / Bestellnr.	Ød	Ød1	L	L1	HEX.
6	R203 00 191	450.06 SFB 10	BSP 1/8	24	52.5	-	20
6	R203 00 192	450.06 SFB 13	BSP 1/4	24	52.5	-	20
6	R203 00 193	450.06 SFB 17	BSP 3/8	24	52.5	-	20
6	R203 00 194	450.06 SFB 21	BSP 1/2	24	54.5	-	24
6	-	450.06 SNB 13	NPT 1/4	24	53.5	-	20
6	-	450.06 SNB 17	NPT 3/8	24	53.5	-	20
6	R303 00 588	450.06 SFB 10 SS	BSP 1/8	24	52.5	-	20
6	R303 00 589	450.06 SFB 13 SS	BSP 1/4	24	52.5	-	20
6	R303 00 590	450.06 SFB 17 SS	BSP 3/8	24	52.5	-	20
6	R303 00 591	450.06 SFB 21 SS	BSP 1/2	24	54.5	-	24
6	R303 00 599	450.06 SNB 13 SS	NPT 1/4	24	53.5	-	20
6	R303 00 600	450.06 SNB 17 SS	NPT 3/8	24	53.5	-	20

*SS: Stainless Steel / Edelstahl

rtc TYPE 450.06

Metal sleeve standard hose socket / Kupplung mit Metallhülse und Schlauchanschluss



Socket / Kupplung

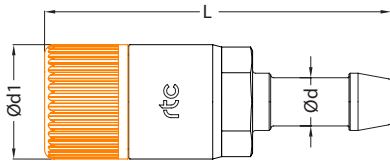

Size / Größe	Alternative Order No Alternative Bestellnr.	Order No / Bestellnr.	Ød	Ød1	L	L1	HEX.
6	R203 00 201	450.06 SHB 06	Ø6 - 1/4	24	68.5	-	-
6	R203 00 198	450.06 SHB 08	Ø8 - 5/16	24	68.5	-	-
6	R203 00 199	450.06 SHB 10	Ø10 - 3/8	24	71.5	-	-
6	R203 00 200	450.06 SHB 13	Ø13 - 1/2	24	71.5	-	-
6	R303 00 595	450.06 SHB 06 SS	Ø6 - 1/4	24	68.5	-	-
6	R303 00 596	450.06 SHB 08 SS	Ø8 - 5/16	24	68.5	-	-
6	R303 00 597	450.06 SHB 10 SS	Ø10 - 3/8	24	71.5	-	-
6	R303 00 598	450.06 SHB 13 SS	Ø13 - 1/2	24	71.5	-	-

*SS: Stainless Steel / Edelstahl

rtc TYPE 450.06

Male thread plug / Nippel mit Aussengewinde



Plug / Nippel

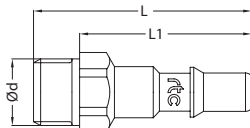

Size / Größe	Alternative Order No Alternative Bestellnr.	Order No / Bestellnr.	Ød	Ød1	L	L1	HEX.
6	R255 00 093	461.06 PMF 10	BSP 1/8	-	44	36	14
6	R255 00 091	461.06 PMF 13	BSP 1/4	-	47	36	14
6	R255 00 092	461.06 PMF 17	BSP 3/8	-	52	40	19
6	R255 00 112	461.06 PTF 13	NPT 1/4	-	47	45	14
6	R255 00 117	461.06 PTF 17	NPT 3/8	-	53	48	19
6	R355 00 125	461.06 PMF 13 SS	BSP 1/4	-	44	36	14
6	R355 00 126	461.06 PMF 17 SS	BSP 3/8	-	47	36	14
6	R355 00 127	461.06 PMF 21 SS	BSP 1/2	-	52	40	19
6	R355 00 129	461.06 PTF 13 SS	NPT 1/4	-	47	45	14
6	R355 00 130	461.06 PTF 17 SS	NPT 3/8	-	53	48	19

*SS: Stainless Steel / Edelstahl



Female thread plug / Nippel mit Innengewinde

TYPE 450.06

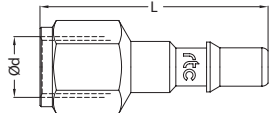

Plug / Nippel	Size / Größe	Alternative Order No Alternative Bestellnr.	Order No / Bestellnr.	Ød	Ød1	L	L1	HEX.
	6	R255 00 100	461.06 PFF 10	BSP 1/8	-	42	-	14
	6	R255 00 088	461.06 PFF 13	BSP 1/4	-	46.5	-	17
	6	R255 00 119	461.06 PNF 13	NPT 1/4	-	46.5	-	17
	6	R355 00 123	461.06 PFF 10 SS	BSP 1/8	-	42	-	14
	6	R355 00 124	461.06 PFF 13 SS	BSP 1/4	-	46.5	-	17
	6	R355 00 208	461.06 PNF 13 SS	NPT 1/4	-	48	-	17
	6	R355 00 264	461.06 PNF 17 SS	NPT 3/8	-	50	-	19

*SS: Stainless Steel / Edelstahl



Standard hose plug / Nippel mit Schlauchanschluss

TYPE 450.06

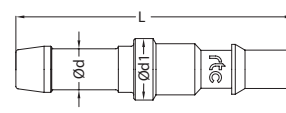

Plug / Nippel	Size / Größe	Alternative Order No Alternative Bestellnr.	Order No / Bestellnr.	Ød	Ød1	L	L1	HEX.
	6	R255 00 113	461.06 PHF 06	Ø6 - 1/4	12	56	-	-
	6	R255 00 114	461.06 PHF 08	Ø8 - 5/16	12	56	-	-
	6	R255 00 115	461.06 PHF 10	Ø10 - 3/8	13	56	-	-
	6	R255 00 116	461.06 PHF 13	Ø13 - 1/2	16.5	60	-	-
	6	R355 00 102	461.06 PHF 06 SS	Ø6 - 1/4	12	56	-	-
	6	R355 00 103	461.06 PHF 08 SS	Ø8 - 5/16	12	56	-	-
	6	R355 00 104	461.06 PHF 10 SS	Ø10 - 3/8	13	56	-	-
	6	R355 00 105	461.06 PHF 13 SS	Ø13 - 1/2	16.5	60	-	-

*SS: Stainless Steel / Edelstahl



Male thread plug with valve / Verschlussnippel mit Aussengewinde

TYPE 450.06

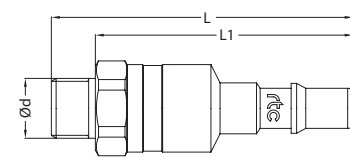

Plug / Nippel	Size / Größe	Alternative Order No Alternative Bestellnr.	Order No / Bestellnr.	Ød	Ød1	L	L1	HEX.
	6	R253 00 171	461.06 PMB 13	BSP 1/4	-	70	60	17
	6	R253 00 172	461.06 PMB 17	BSP 3/8	-	70	60	19
	6	-	461.06 PTB 13	NPT 1/4	-	72	60	17
	6	R353 00 119	461.06 PMB 13 SS	BSP 1/4	-	70	60	17
	6	R353 00 120	461.06 PMB 17 SS	BSP 3/8	-	70	60	19
	6	R353 00 311	461.06 PTB 13 SS	NPT 1/4	-	72	60	17
	6	R353 00 312	461.06 PTB 17 SS	NPT 3/8	-	73	60	19

*SS: Stainless Steel / Edelstahl



Female thread plug with valve / Verschlussnippel mit Innengewinde

TYPE 450.06

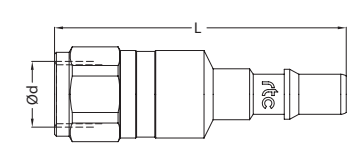

Plug / Nippel	Size / Größe	Alternative Order No Alternative Bestellnr.	Order No / Bestellnr.	Ød	Ød1	L	L1	HEX.
	6	R253 00 169	461.06 PFB 13	BSP 1/4	-	72	-	17
	6	R253 00 170	461.06 PFB 17	BSP 3/8	-	72	-	22
	6	-	461.06 PNB 13	NPT 1/4	-	72	-	17
	6	R353 00 117	461.06 PFB 13 SS	BSP 1/4	-	72	-	17
	6	R353 00 118	461.06 PFB 17 SS	BSP 3/8	-	72	-	22
	6	R353 00 309	461.06 PNB 13 SS	NPT 1/4	-	72	-	17
	6	R353 00 310	461.06 PNB 17 SS	NPT 3/8	-	72	-	22

*SS: Stainless Steel / Edelstahl



Standard hose plug with valve / Verschlussnippel mit Schlauchanschluss

TYPE 450.06



Plug / Nippel	Size / Größe	Alternative Order No Alternative Bestellnr.	Order No / Bestellnr.	Ød	Ød1	L	L1	HEX.
	6	R253 00 173	461.06 PHB 06	Ø6 - 1/4	-	79	-	17
	6	R253 00 174	461.06 PHB 08	Ø8 - 5/16	-	79	-	17
	6	R253 00 175	461.06 PHB 10	Ø10 - 3/8	-	79	-	17
	6	R353 00 121	461.06 PHB 06 SS	Ø6 - 1/4	-	79	-	17
	6	R353 00 122	461.06 PHB 08 SS	Ø8 - 5/16	-	79	-	17
	6	R353 00 123	461.06 PHB 10 SS	Ø10 - 3/8	-	79	-	17
	6	R353 00 313	461.06 PHB 13 SS	Ø13 - 1/2	-	82	-	17

*SS: Stainless Steel / Edelstahl



rtc[®]

QUICK CONNECT TECHNOLOGY
www.rtc-tec.com

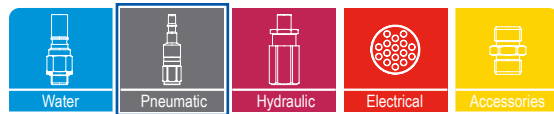

450.08

rtc TYPE





Compatible - Kompatibilität

rtc	170.08
rtc	171.08
rtc	173.08
rtc	451.08
rtc	461.08 / SC-E1

Temperature Range - Temperaturbereich

Nitrile (N)	-20°C + 110°C (- 4°F + 230°F)
FPM (V)	-20°C + 180°C (- 4°F + 356°F)
EPDM (Ethylene Propylene)	-40°C + 150°C (- 40°F + 302°F)

Working Pressure - Betriebsdruck

25 Bar (360 PSI)

Connction / Disconnection Max. Pressure -

Ein- und Auskuppelbar bis Max. Druck
15 Bar (220 PSI)

Flow size - Nennweite

rtc type 450.08 8mm (3/8")

Standard version - Standardversion

Seals - Dichtung : Nitrile (N)

Material of steel version / Material für die Stahl Version

Socket Body - Kupplungsgrundkörper	Steel tenifer threaded Stahl teneferiert
Back Part - Hinterteil	Steel zinc nickel plated Stahl Zink-Nickel beschichtet
Sleeve - Hülse	Steel zinc-nickel plated and orange painted Stahl Zink-Nickel beschichtet und orange lackiert
Spings - Federn	Stainless steel - Edelstahl
Seals - Dichtungen	Nitrile (N)
Plug - Nippel	Steel tenifer threaded Stahl teneferiert

Advantages

- The system perfectly fits to the **ISO 4414, EN 983** safety requirements.
- Plug profile perfectly fits to the **ISO 6150-C-14, AFNOR C-14 NF E 49-053**
- 2 stage disconnection safety feature
- Negligible Connecting Force
- Smart and Ergonomic features
- Ease of Handling
- Optimised Size

Vorteil

- Sicherheit gemäß **ISO 4414, EN 983**
- Stecknippel gemäß **ISO 6150-C-14, AFNOR C-14 NF E 49-053**
- 2 stufen Sicherheitsentriegelung
- Einfache Bedienung, sehr geringe Kuppelkraft
- Kompakte Bauform

Material of stainless the steel version

Material für die Edelstahlversion

Socket Body - Kupplungsgrundkörper	Stainless steel Edelstahl
Back Part - Hinterteil	Stainless steel - Edelstahl
Sleeve - Hülse	Stainless steel - Edelstahl
Spings - Federn	Stainless steel - Edelstahl
Seals - Dichtungen	FPM (V)
Plug - Nippel	Stainless steel - Edelstahl



Flow Rate vs Pressure Drop Graph

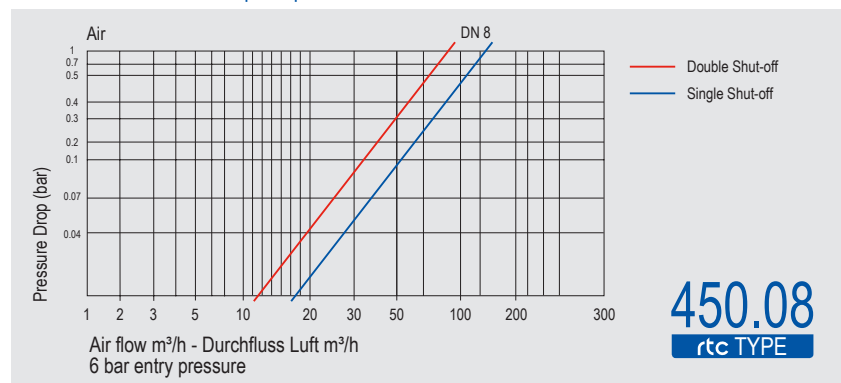

rtc TYPE 450.08

Metal sleeve socket with male thread / Kupplung mit Metallhülse und Aussengewinde



Socket / Kupplung

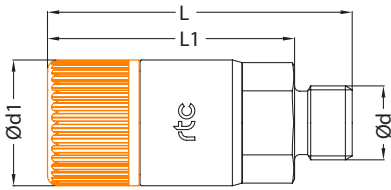

*SS: Stainless Steel / Edelstahl

Size / Größe	Alternative Order No Alternative Bestellnr.	Order No / Bestellnr.	Ød	Ød1	L	L1	HEX.
8	R203 00 316	450.08 SMB 17	BSP 3/8	30	72	62	24
8	R203 00 318	450.08 SMB 21	BSP 1/2	30	74	62	24
8	-	450.08 STB 17	NPT 3/8	30	74	62	24
8	-	450.08 STB 21	NPT 1/2	30	79	62	24
8	R303 00 607	450.08 SMB 17 SS	BSP 3/8	30	72	62	24
8	R303 00 608	450.08 SMB 21 SS	BSP 1/2	30	74	62	24
8	R303 00 609	450.08 STB 17 SS	NPT 3/8	30	74	62	24
8	R303 00 610	450.08 STB 21 SS	NPT 1/2	30	79	62	24

rtc TYPE 450.08

Metal sleeve socket with female thread / Kupplung mit Metallhülse und Innengewinde



Socket / Kupplung

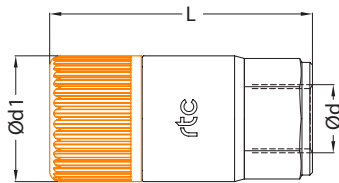

*SS: Stainless Steel / Edelstahl

Size / Größe	Alternative Order No Alternative Bestellnr.	Order No / Bestellnr.	Ød	Ød1	L	L1	HEX.
8	R203 00 307	450.08 SFB 13	BSP 1/4	30	72	-	24
8	R203 00 309	450.08 SFB 17	BSP 3/8	30	72	-	24
8	R203 00 312	450.08 SFB 21	BSP 1/2	30	75	-	24
8	-	450.08 SNB 17	NPT 3/8	30	73	-	24
8	-	450.08 SNB 21	NPT 1/2	30	80	-	24
8	R303 00 300	450.08 SFB 13 SS	BSP 1/4	30	72	-	24
8	R303 00 603	450.08 SFB 17 SS	BSP 3/8	30	72	-	24
8	R303 00 604	450.08 SFB 21 SS	BSP 1/2	30	75	-	24
8	R303 00 605	450.08 SNB 17 SS	NPT 3/8	30	73	-	24
8	R303 00 606	450.08 SNB 21 SS	NPT 1/2	30	80	-	24

rtc TYPE 450.08

Metal sleeve standard hose socket / Kupplung mit Metallhülse und Schlauchanschluss



Socket / Kupplung

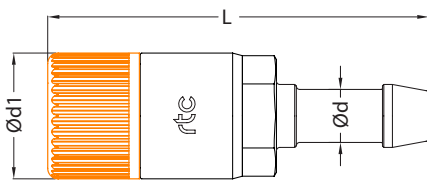

*SS: Stainless Steel / Edelstahl

Size / Größe	Alternative Order No Alternative Bestellnr.	Order No / Bestellnr.	Ød	Ød1	L	L1	HEX.
8	R203 00 322	450.08 SHB 08	Ø8 - 5/16	30	84	-	-
8	R203 00 325	450.08 SHB 10	Ø10 - 3/8	30	87	-	-
8	R203 00 327	450.08 SHB 13	Ø13 - 1/2	30	87	-	-
8	R203 00 330	450.08 SHB 16	Ø16 - 5/8	30	87	-	-
8	R303 00 611	450.08 SHB 08 SS	Ø8 - 5/16	30	84	-	-
8	R303 00 612	450.08 SHB 10 SS	Ø10 - 3/8	30	87	-	-
8	R303 00 613	450.08 SHB 13 SS	Ø13 - 1/2	30	87	-	-
8	R303 00 614	450.08 SHB 16 SS	Ø16 - 5/8	30	87	-	-

rtc TYPE 450.08

Male thread plug / Nippel mit Aussengewinde



Plug / Nippel

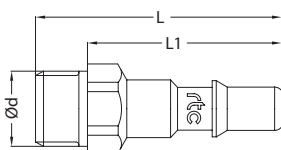

*SS: Stainless Steel / Edelstahl

Size / Größe	Alternative Order No Alternative Bestellnr.	Order No / Bestellnr.	Ød	Ød1	L	L1	HEX.
8	R255 00 101	461.08 PMF 13	BSP 1/4	-	55	44	17
8	R255 00 102	461.08 PMF 17	BSP 3/8	-	57	44.5	19
8	-	461.08 PMF 21	BSP 1/2	-	60	48	24
8	R255 00 090	461.08 PTF 13	NPT 1/4	-	57	44.5	17
8	R255 00 089	461.08 PTF 17	NPT 3/8	-	57	44.5	19
8	R355 00 090	461.08 PMF 13 SS	BSP 1/4	-	55	44	17
8	R355 00 091	461.08 PMF 17 SS	BSP 3/8	-	57	44.5	19
8	-	461.08 PMF 21 SS	BSP 1/2	-	60	48	24
8	R355 00 092	461.08 PTF 13 SS	NPT 1/4	-	57	44.5	17
8	R355 00 093	461.08 PTF 17 SS	NPT 3/8	-	57	44.5	19

Female thread plug / Nippel mit Innengewinde TYPE 450.08 

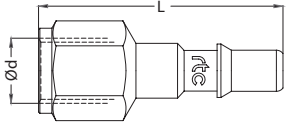
Plug / Nippel	Size / Größe	Alternative Order No Alternative Bestellnr.	Order No / Bestellnr.	Ød	Ød1	L	L1	HEX.
	8	R255 00 103	461.08 PFF 13	BSP 1/4	-	55.5	-	17
	8	R255 00 105	461.08 PFF 17	BSP 3/8	-	57.5	-	22
	8	-	461.08 PFF 21	BSP 1/2	-	59	-	27
	8	R255 00 104	461.08 PNF 13	NPT 1/4	-	56.5	-	17
	8	R255 00 106	461.08 PNF 17	NPT 3/8	-	57.5	-	22
	8	-	461.08 PNF 21	NPT 1/2	-	61	-	27
	8	R355 00 088	461.06 PFF 13 SS	BSP 1/4	-	55.5	-	17
	8	R355 00 089	461.06 PFF 17 SS	BSP 3/8	-	57.5	-	22
	8	-	461.06 PFF 21 SS	BSP 1/2	-	59	-	27
	8	R355 00 094	461.06 PNF 13 SS	NPT 1/4	-	56.5	-	17
	8	R355 00 095	461.06 PNF 17 SS	NPT 3/8	-	57.5	-	22
	8	R355 00 359	461.06 PNF 21 SS	NPT 1/2	-	61	-	27

*SS: Stainless Steel / Edelstahl

Standard hose plug / Nippel mit Schlauchanschluss TYPE 450.08 

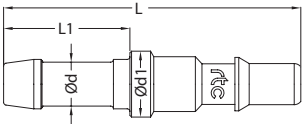
Plug / Nippel	Size / Größe	Alternative Order No Alternative Bestellnr.	Order No / Bestellnr.	Ød	Ød1	L	L1	HEX.
	8	R255 00 107	461.08 PHF 08	Ø8 - 5/16	15	62	-	-
	8	R255 00 108	461.08 PHF 10	Ø10 - 3/8	15	62	-	-
	8	R255 00 109	461.08 PHF 13	Ø13 - 1/2	17	66	-	-
	8	R255 00 110	461.08 PHF 16	Ø16 - 5/8	19	66	-	-
	8	R355 00 096	461.08 PHF 08 SS	Ø8 - 5/16	15	62	-	-
	8	R355 00 097	461.08 PHF 10 SS	Ø10 - 3/8	15	62	-	-
	8	R355 00 098	461.08 PHF 13 SS	Ø13 - 1/2	17	66	-	-
	8	R355 00 099	461.08 PHF 16 SS	Ø16 - 5/8	19	66	-	-

*SS: Stainless Steel / Edelstahl

Male thread plug with valve / Verschlussnippel mit Aussengewinde TYPE 450.08 

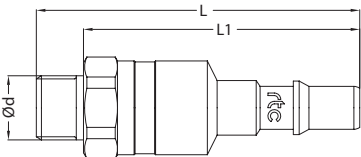
Plug / Nippel	Size / Größe	Alternative Order No Alternative Bestellnr.	Order No / Bestellnr.	Ød	Ød1	L	L1	HEX.
	8	R253 00 159	461.08 PMB 17	BSP 3/8	-	86	74	24
	8	-	461.08 PMB 21	BSP 1/2	-	88	74	24
	8	-	461.08 PTB 17	NPT 3/8	-	88	74	24
	8	R353 00 102	461.08 PMB 17 SS	BSP 3/8	-	86	74	24
	8	-	461.08 PMB 21 SS	BSP 1/2	-	88	74	24
	8	R353 00 315	461.08 PTB 17 SS	NPT 3/8	-	88	74	24

*SS: Stainless Steel / Edelstahl

Female thread plug with valve / Verschlussnippel mit Innengewinde TYPE 450.08 

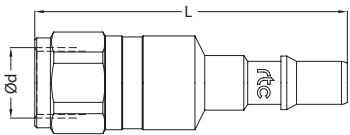
Plug / Nippel	Size / Größe	Alternative Order No Alternative Bestellnr.	Order No / Bestellnr.	Ød	Ød1	L	L1	HEX.
	8	R253 00 157	461.08 PFB 17	BSP 3/8	-	80	-	24
	8	-	461.08 PFB 21	BSP 1/2	-	82	-	24
	8	-	461.08 PNB 17	NPT 3/8	-	80	-	24
	8	R353 00 100	461.08 PFB 17 SS	BSP 3/8	-	80	-	24
	8	-	461.08 PFB 21 SS	BSP 1/2	-	82	-	24
	8	R353 00 314	461.08 PNB 17 SS	NPT 3/8	-	80	-	24

*SS: Stainless Steel / Edelstahl

Standard hose plug with valve / Verschlussnippel mit Schlauchanschluss TYPE 450.08 

Plug / Nippel	Size / Größe	Alternative Order No Alternative Bestellnr.	Order No / Bestellnr.	Ød	Ød1	L	L1	HEX.
	8	R253 00 161	461.08 PHB 10	Ø10 - 3/8	-	97	-	24
	8	R253 00 163	461.08 PHB 13	Ø13 - 1/2	-	100	-	24
	8	R353 00 104	461.08 PHB 10 SS	Ø10 - 3/8	-	97	-	24
	8	R353 00 106	461.08 PHB 13 SS	Ø13 - 1/2	-	100	-	24

*SS: Stainless Steel / Edelstahl



rtc[®]

QUICK CONNECT TECHNOLOGY
www.rtc-tec.com



450.11

rtc TYPE





Compatible - Kompatibilität

rtc	170.11
rtc	171.11
rtc	173.11
rtc	451.11
rtc	461.11 / SC-G

Temperature Range - Temperaturbereich

Nitrile (N)	-20°C + 110°C (-4°F + 230°F)
FPM (V)	-20°C + 180°C (-4°F + 356°F)
EPDM (Ethylene Propylene)	-40°C + 150°C (-40°F + 302°F)

Working Pressure - Betriebsdruck

25 Bar (360 PSI)

Connction / Disconnection Max. Pressure - Ein- und Auskuppelbar bis Max. Druck

15 Bar (220 PSI)

Flow size - Nennweite

rtc type 450.11 11mm (1/2")

Standard version - Standardversion

Seals - Dichtung : Nitrile (N)

Material of steel version / Material für die Stahl Version

Socket Body - Kupplungsgrundkörper	Steel tenifer threaded Stahl teneferiert
Back Part - Hinterteil	Steel zinc nickel plated Stahl Zink-Nickel beschichtet
Sleeve - Hülse	Steel zinc nickel plated and orange painted Stahl Zink-Nickel beschichtet und orange lackiert
Springs - Federn	Stainless steel - Edelstahl
Seals - Dichtungen	Nitrile (N)
Plug - Nippel	Steel tenifer threaded Stahl teneferiert

Advantages

- The system perfectly fits to the **ISO 4414, EN 983** safety requirements.
- Plug profile perfectly fits to the **ISO 6150-C-17, AFNOR C-17 NF E 49-053**
- 2 stage disconnection safety feature
- Through flow, minimum pressure loss.
- Negligible Connecting Force
- Smart and Ergonomic features
- Ease of Handling
- Optimised Size

Vorteil

- Sicherheit gemäß **ISO 4414, EN 983**
- Stecknippel gemäß **ISO 6150-C-17, AFNOR C-17 NF E 49-053**
- 2 stufen Sicherheitsentriegelung
- Voller Durchgang, sehr geringer Druckverlust
- Einfache Bedienung, sehr geringe Kuppelkraft
- Kompakte Bauform

Material of stainless the steel version

Material für die Edelstahlversion

Socket Body - Kupplungsgrundkörper	Stainless steel Edelstahl
Back Part - Hinterteil	Stainless steel - Edelstahl
Sleeve - Hülse	Stainless steel - Edelstahl
Springs - Federn	Stainless steel - Edelstahl
Seals - Dichtungen	FPM (V)
Plug - Nippel	Stainless steel - Edelstahl



Flow Rate vs Pressure Drop Graph

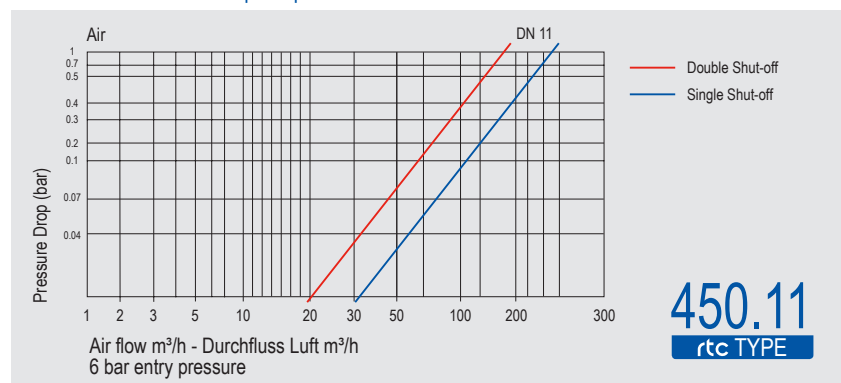

rtc TYPE 450.11

Metal sleeve socket with male thread / Kupplung mit Metallhülse und Aussengewinde



Socket / Kupplung

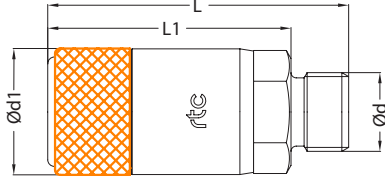

Size / Größe	Alternative Order No Alternative Bestellnr.	Order No / Bestellnr.	Ød	Ød1	L	L1	HEX.
11	R203 00 056	450.11 SMB 17	BSP 3/8	38	89.5	77.5	30
11	R203 00 058	450.11 SMB 21	BSP 1/2	38	91.5	77.5	30
11	R203 00 060	450.11 SMB 26	BSP 3/4	38	93.5	77.5	30
11	-	450.11 STB 17	NPT 3/8	38	89.5	77.5	30
11	-	450.11 STB 21	NPT 1/2	38	94.5	77.5	30
11	-	450.11 STB 26	NPT 3/4	38	96.5	77.5	30
11	R303 00 621	450.11 SMB 17 SS	BSP 3/8	38	89.5	77.5	30
11	R303 00 622	450.11 SMB 21 SS	BSP 1/2	38	91.5	77.5	30
11	R303 00 623	450.11 SMB 26 SS	BSP 3/4	38	93.5	77.5	30
11	R303 00 624	450.11 SMB 33 SS	BSP 1	38	95.5	77.5	34
11	R303 00 625	450.11 STB 17 SS	NPT 3/8	38	89.5	77.5	30
11	R303 00 626	450.11 STB 21 SS	NPT 1/2	38	94.5	77.5	30
11	R303 00 627	450.11 STB 26 SS	NPT 3/4	38	96.5	77.5	30

*SS: Stainless Steel / Edelstahl

rtc TYPE 450.11

Metal sleeve socket with female thread / Kupplung mit Metallhülse und Innengewinde



Socket / Kupplung

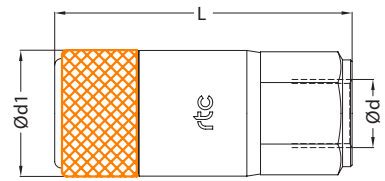

Size / Größe	Alternative Order No Alternative Bestellnr.	Order No / Bestellnr.	Ød	Ød1	L	L1	HEX.
11	R203 00 050	450.11 SFB 17	BSP 3/8	38	83	-	30
11	R203 00 052	450.11 SFB 21	BSP 1/2	38	83.5	-	30
11	R203 00 054	450.11 SFB 26	BSP 3/4	38	87.5	-	30
11	-	450.11 SNB 17	NPT 3/8	38	83.5	-	30
11	-	450.11 SNB 21	NPT 1/2	38	88	-	30
11	-	450.11 SNB 26	NPT 3/4	38	90	-	30
11	R303 00 615	450.11 SFB 17 SS	BSP 3/8	38	83	-	30
11	R303 00 616	450.11 SFB 21 SS	BSP 1/2	38	83.5	-	30
11	R303 00 617	450.11 SFB 26 SS	BSP 3/4	38	87.5	-	30
11	R303 00 618	450.11 SNB 17 SS	NPT 3/8	38	83.5	-	30
11	R303 00 619	450.11 SNB 21 SS	NPT 1/2	38	88	-	30
11	R303 00 620	450.11 SNB 26 SS	NPT 3/4	38	90	-	30

*SS: Stainless Steel / Edelstahl

rtc TYPE 450.11

Metal sleeve standard hose socket / Kupplung mit Metallhülse und Schlauchanschluss



Socket / Kupplung

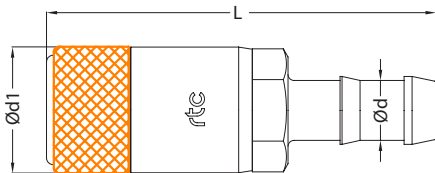

Size / Größe	Alternative Order No Alternative Bestellnr.	Order No / Bestellnr.	Ød	Ød1	L	L1	HEX.
11	R203 00 064	450.11 SHB 13	Ø13 - 1/2	38	98.5	-	-
11	R203 00 066	450.11 SHB 16	Ø16 - 5/8	38	98.5	-	-
11	R203 00 068	450.11 SHB 19	Ø19 - 3/4	38	110	-	-
11	R303 00 628	450.11 SHB 13 SS	Ø13 - 1/2	38	98.5	-	-
11	R303 00 154	450.11 SHB 16 SS	Ø16 - 5/8	38	98.5	-	-
11	R303 00 156	450.11 SHB 19 SS	Ø19 - 3/4	38	110	-	-

*SS: Stainless Steel / Edelstahl

Male thread plug / Nippel mit Aussengewinde TYPE 450.11 **rtc**

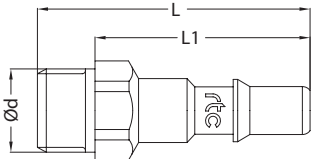
Plug / Nippel	Size / Größe	Alternative Order No Alternative Bestellnr.	Order No / Bestellnr.	Ød	Ød1	L	L1	HEX.
	11	R255 00 131	461.11 PMF 17	BSP 3/8	-	63	51	19
	11	R255 00 132	461.11 PMF 21	BSP 1/2	-	68	53	24
	11	R255 00 133	461.11 PMF 26	BSP 3/4	-	70	53	30
	11	R255 00 137	461.11 PTF 17	NPT 3/8	-	62	51	19
	11	R255 00 138	461.11 PTF 21	NPT 1/2	-	67	50	24
	11	R255 00 139	461.11 PTF 26	NPT 3/4	-	70	51	27
	11	R355 00 110	461.11 PMF 17 SS	BSP 3/8	-	63	51	19
	11	R355 00 111	461.11 PMF 21 SS	BSP 1/2	-	68	53	24
	11	R355 00 112	461.11 PMF 26 SS	BSP 3/4	-	70	53	30
	11	R355 00 116	461.11 PTF 17 SS	NPT 3/8	-	62	51	19
	11	R355 00 117	461.11 PTF 21 SS	NPT 1/2	-	67	50	24
	11	R355 00 118	461.11 PTF 26 SS	NPT 3/4	-	70	51	27

*SS: Stainless Steel / Edelstahl

Female thread plug / Nippel mit Innengewinde TYPE 450.11 **rtc**

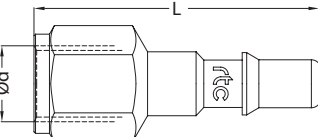
Plug / Nippel	Size / Größe	Alternative Order No Alternative Bestellnr.	Order No / Bestellnr.	Ød	Ød1	L	L1	HEX.
	11	R255 00 128	461.11 PFF 17	BSP 3/8	-	62	-	22
	11	R255 00 129	461.11 PFF 21	BSP 1/2	-	66	-	27
	11	R255 00 130	461.11 PFF 26	BSP 3/4	-	69	-	32
	11	R255 00 134	461.11 PNF 17	NPT 3/8	-	62	-	22
	11	R255 00 135	461.11 PNF 21	NPT 1/2	-	67	-	27
	11	R255 00 136	461.11 PNF 26	NPT 3/4	-	69	-	32
	11	R355 00 107	461.11 PFF 17 SS	BSP 3/8	-	62	-	22
	11	R355 00 108	461.11 PFF 21 SS	BSP 1/2	-	66	-	27
	11	R355 00 109	461.11 PFF 26 SS	BSP 3/4	-	69	-	32
	11	R355 00 113	461.11 PNF 17 SS	NPT 3/8	-	62	-	22
	11	R355 00 114	461.11 PNF 21 SS	NPT 1/2	-	67	-	27
	11	R355 00 115	461.11 PNF 26 SS	NPT 3/4	-	69	-	32

*SS: Stainless Steel / Edelstahl

Standard hose plug / Nippel mit Schlauchanschluss TYPE 450.11 **rtc**

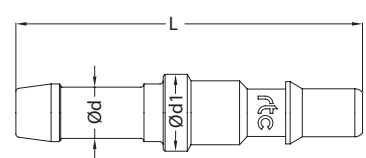
Plug / Nippel	Size / Größe	Alternative Order No Alternative Bestellnr.	Order No / Bestellnr.	Ød	Ød1	L	L1	HEX.
	11	R255 00 140	461.11 PHF 10	Ø10 - 3/8	19	70.5	-	-
	11	R255 00 141	461.11 PHF 13	Ø13 - 1/2	19	70.5	-	-
	11	R255 00 142	461.11 PHF 16	Ø16 - 5/8	21	72	-	-
	11	R255 00 143	461.11 PHF 19	Ø19 - 3/4	23	85	-	-
	11	R355 00 119	461.11 PHF 10 SS	Ø10 - 3/8	19	70.5	-	-
	11	R355 00 120	461.11 PHF 13 SS	Ø13 - 1/2	19	70.5	-	-
	11	R355 00 121	461.11 PHF 16 SS	Ø16 - 5/8	21	72	-	-
	11	R355 00 122	461.11 PHF 19 SS	Ø19 - 3/4	23	85	-	-

*SS: Stainless Steel / Edelstahl

rtc TYPE 450.11

Male thread plug with valve / Verschlussnippel mit Aussengewinde



Plug / Nippel

Size / Größe	Alternative Order No Alternative Bestellnr.	Order No / Bestellnr.	Ød	Ød1	L	L1	HEX.
11	-	461.11 PMB 17	BSP 3/8	-	94.5	82.5	30
11	R253 00 020	461.11 PMB 21	BSP 1/2	-	95.5	82.5	30
11	-	461.11 PMB 26	BSP 3/4	-	99.5	82.5	30
11	-	461.11 PTB 17	NPT 3/8	-	94.5	82.5	30
11	-	461.11 PTB 21	NPT 1/2	-	99.5	82.5	30
11	R353 00 320	461.11 PMB 17 SS	BSP 3/8	-	94.5	82.5	30
11	R353 00 268	461.11 PMB 21 SS	BSP 1/2	-	95.5	82.5	30
11	R353 00 321	461.11 PMB 26 SS	BSP 3/4	-	99.5	82.5	30
11	R353 00 322	461.11 PTB 17 SS	NPT 3/8	-	94.5	82.5	30
11	R353 00 323	461.11 PTB 21 SS	NPT 1/2	-	99.5	82.5	30

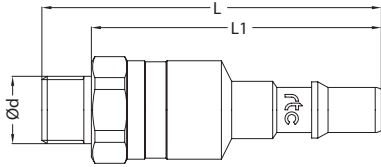

*SS: Stainless Steel / Edelstahl

rtc TYPE 450.11

Female thread plug with valve / Verschlussnippel mit Innengewinde



Plug / Nippel

Size / Größe	Alternative Order No Alternative Bestellnr.	Order No / Bestellnr.	Ød	Ød1	L	L1	HEX.
11	-	461.11 PFB 17	BSP 3/8	-	90	-	30
11	R253 00 019	461.11 PFB 21	BSP 1/2	-	94	-	30
11	-	461.11 PNB 17	NPT 3/8	-	90	-	30
11	-	461.11 PNB 21	NPT 1/2	-	94	-	30
11	R353 00 316	461.11 PFB 17 SS	BSP 3/8	-	90	-	30
11	R353 00 317	461.11 PFB 21 SS	BSP 1/2	-	94	-	30
11	R353 00 318	461.11 PNB 17 SS	NPT 3/8	-	90	-	30
11	R353 00 319	461.11 PNB 21 SS	NPT 1/2	-	94	-	30

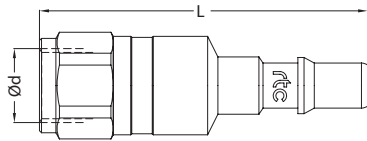

*SS: Stainless Steel / Edelstahl

rtc TYPE 450.11

Standard hose plug with valve / Verschlussnippel mit Schlauchanschluss



Plug / Nippel

Size / Größe	Alternative Order No Alternative Bestellnr.	Order No / Bestellnr.	Ød	Ød1	L	L1	HEX.
11	R253 00 021	461.11 PHB 13	Ø13 - 1/2	-	108.5	-	30
11	R253 00 022	461.11 PHB 16	Ø16 - 5/8	-	108.5	-	30
11	-	461.11 PHB 19	Ø19 - 3/4	-	119.5	-	30
11	R353 00 324	461.11 PHB 13 SS	Ø13 - 1/2	-	108.5	-	30
11	R353 00 147	461.11 PHB 16 SS	Ø16 - 5/8	-	108.5	-	30
11	R353 00 222	461.11 PHB 19 SS	Ø19 - 3/4	-	119.5	-	30

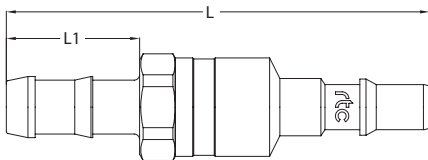

*SS: Stainless Steel / Edelstahl

MULTI CONNECT TECHNOLOGY

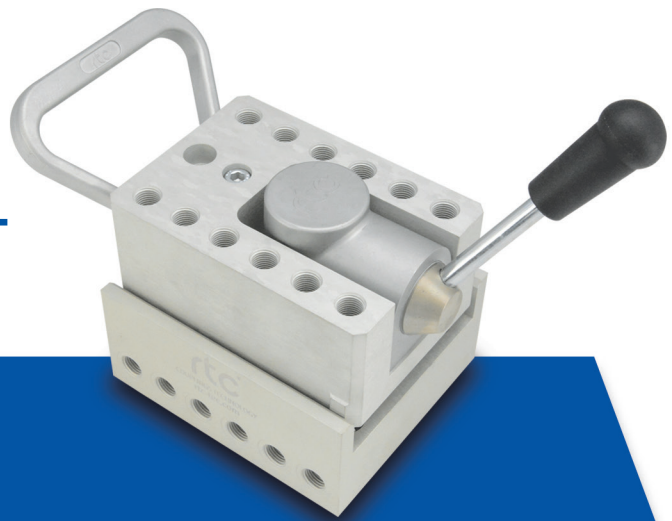

www.rtc-tec.com

QUICK CONNECT TECHNOLOGY



Water



Pneumatic



Hydraulic



Electrical



Accessories



rtc[®]

QUICK CONNECT TECHNOLOGY
www.rtc-tec.com

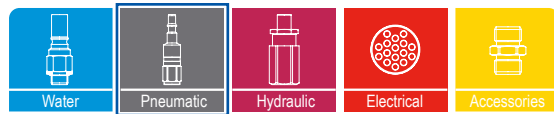

451.06

rtc TYPE





Compatible - Kompatibilität

rtc	170.06
rtc	171.06
rtc	173.06
rtc	450.06
rtc	461.06 / SC-K

Temperature Range - Temperaturbereich

Nitrile (N)	-20°C + 110°C (- 4°F + 230°F)
FPM (V)	-20°C + 180°C (- 4°F + 356°F)
EPDM (Ethylene Propylene)	-40°C + 150°C (- 40°F + 302°F)

Working Pressure - Betriebsdruck

25 Bar (360 PSI)

Connction / Disconnection Max. Pressure -

Ein- und Auskuppelbar bis Max. Druck
15 Bar (220 PSI)

Flow size - Nennweite

rtc type 451.06 5.5mm (1/4")

Standard version - Standardversion

Seals - Dichtung : Nitrile (N)

Material of standard version with plastic release ring

Material für die Standardversion mit Kunststoffauslösering

Socket Body -	Steel tenifer threaded
Kupplungsgrundkörper	Stahl teneferiert
Back Part -	Steel zinc nickel plated
Hinterteil	Stahl Zink-Nickel beschichtet
Sleeve -	Orange colour plastic
Hülse	Kunststoff, Farbe orange
Springs - Federn	Stainless steel - Edelstahl
Seals - Dichtungen	Nitrile (N)

Plug	Steel tenifer threaded
Nippel	Stahl teneferiert

Advantages

- The system perfectly fits to the **ISO 4414, EN 983** safety requirements.
- Plug profile perfectly fits to the **ISO 6150-C-10, AFNOR C-10 NF E 49-053**
- 2 stage disconnection safety feature
- Through flow, minimum pressure loss
- Negligible Connecting Force
- Smart and Ergonomic features
- Ease of Handling
- Optimised Size

Vorteil

- Sicherheit gemäß **ISO 4414, EN 983**
- Stecknippel gemäß **ISO 6150-C-10, AFNOR C-10 NF E 49-053**
- 2 stufen Sicherheitsentriegelung
- Voller Durchgang, sehr geringer Druckverlust
- Einfache Bedienung, sehr geringe Kuppelkraft
- Kompakte Bauform



Flow Rate vs Pressure Drop Graph

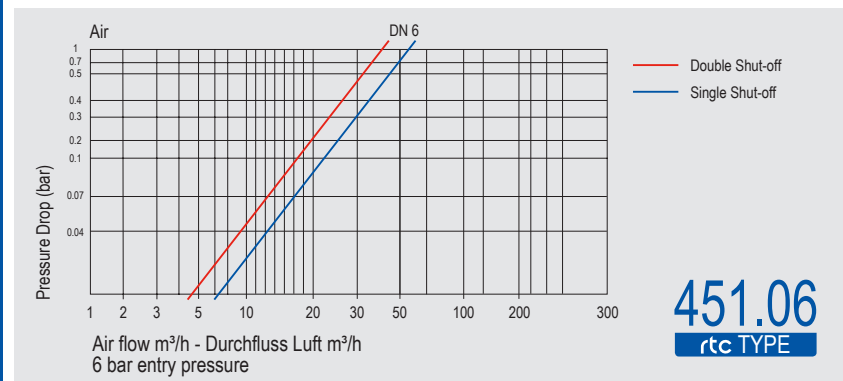

rtc TYPE 451.06

Plastic sleeve socket with male thread / Kupplung mit Kunststoffdrehhülse und Aussengewinde



Socket / Kupplung

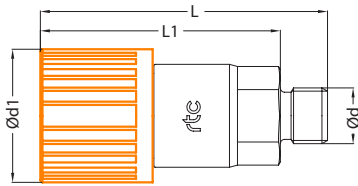

Size / Größe	Alternative Order No Alternative Bestellnr.	Order No / Bestellnr.	Ød	Ød1	L	L1	HEX.
6	R203 00 186	451.06 SMB 13	BSP 1/4	31.5	52.5	42.5	20
6	R203 00 184	451.06 SMB 17	BSP 3/8	31.5	52.5	42.5	20
6	R203 00 185	451.06 SMB 21	BSP 1/2	31.5	54.5	42.5	22
6	-	451.06 STB 13	NPT 1/4	31.5	54.5	42.5	20
6	-	451.06 STB 17	NPT 3/8	31.5	54.5	42.5	20

rtc TYPE 451.06

Plastic sleeve socket with female thread / Kupplung mit Kunststoffdrehhülse und Innengewinde



Socket / Kupplung

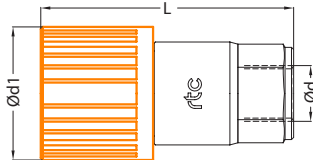

Size / Größe	Alternative Order No Alternative Bestellnr.	Order No / Bestellnr.	Ød	Ød1	L	L1	HEX.
6	R203 00 180	451.06 SFB 10	BSP 1/8	31.5	52.5	-	20
6	R203 00 181	451.06 SFB 13	BSP 1/4	31.5	52.5	-	20
6	R203 00 182	451.06 SFB 17	BSP 3/8	31.5	55.5	-	20
6	R203 00 183	451.06 SFB 21	BSP 1/2	31.5	59.5	-	24
6	-	451.06 SNB 13	NPT 1/4	31.5	56.5	-	20
6	-	451.06 SNB 17	NPT 3/8	31.5	56.5	-	20

rtc TYPE 451.06

Plastic sleeve standard hose socket / Kupplung mit Kunststoffdrehhülse und Schlauchanschluss



Socket / Kupplung

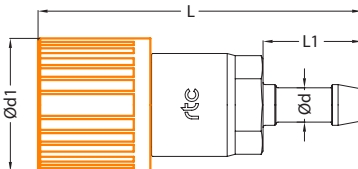

Size / Größe	Alternative Order No Alternative Bestellnr.	Order No / Bestellnr.	Ød	Ød1	L	L1	HEX.
6	R203 00 190	451.06 SHB 06	Ø6 - 1/4	31.5	65.5	23	-
6	R203 00 187	451.06 SHB 08	Ø8 - 5/16	31.5	65.5	23	-
6	R203 00 188	451.06 SHB 10	Ø10 - 3/8	31.5	68.5	23	-
6	R203 00 189	451.06 SHB 13	Ø13 - 1/2	31.5	68.5	26	-

rtc TYPE 451.06

Male thread plug / Nippel mit Aussengewinde



Plug / Nippel

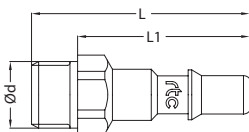

Size / Größe	Alternative Order No Alternative Bestellnr.	Order No / Bestellnr.	Ød	Ød1	L	L1	HEX.
6	R255 00 093	461.06 PMF 10	BSP 1/8	-	44	36	14
6	R255 00 091	461.06 PMF 13	BSP 1/4	-	47	36	14
6	R255 00 092	461.06 PMF 17	BSP 3/8	-	52	40	19
6	R255 00 112	461.06 PTF 13	NPT 1/4	-	48	45	14
6	R255 00 117	461.06 PTF 17	NPT 3/8	-	53	48	19
6	R355 00 125	461.06 PMF 13 SS	BSP 1/4	-	44	36	14
6	R355 00 126	461.06 PMF 17 SS	BSP 3/8	-	47	36	14
6	R355 00 127	461.06 PMF 21 SS	BSP 1/2	-	52	40	19
6	R355 00 129	461.06 PTF 13 SS	NPT 1/4	-	48	45	14
6	R355 00 130	461.06 PTF 17 SS	NPT 3/8	-	53	48	19

*SS: Stainless Steel / Edelstahl



Female thread plug / Nippel mit Innengewinde

TYPE 451.06



Plug / Nippel

Size / Größe	Alternative Order No Alternative Bestellnr.	Order No / Bestellnr.	Ød	Ød1	L	L1	HEX.
6	R255 00 100	461.06 PFF 10	BSP 1/8	-	42	-	14
6	R255 00 088	461.06 PFF 13	BSP 1/4	-	46.5	-	17
6	R255 00 119	461.06 PNF 13	NPT 1/4	-	46.5	-	17
6	R355 00 123	461.06 PFF 10 SS	BSP 1/8	-	42	-	14
6	R355 00 124	461.06 PFF 13 SS	BSP 1/4	-	46.5	-	17
6	R355 00 208	461.06 PNF 13 SS	NPT 1/4	-	48	-	17
6	R355 00 264	461.06 PNF 17 SS	NPT 3/8	-	50	-	19

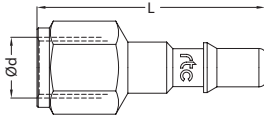

*SS: Stainless Steel / Edelstahl



Standard hose plug / Nippel mit Schlauchanschluss

TYPE 450.06



Plug / Nippel

Size / Größe	Alternative Order No Alternative Bestellnr.	Order No / Bestellnr.	Ød	Ød1	L	L1	HEX.
6	R255 00 113	461.06 PHF 06	Ø6 - 1/4	12	56	-	-
6	R255 00 114	461.06 PHF 08	Ø8 - 5/16	12	56	-	-
6	R255 00 115	461.06 PHF 10	Ø10 - 3/8	13	56	-	-
6	R255 00 116	461.06 PHF 13	Ø13 - 1/2	16.5	60	-	-
6	R355 00 102	461.06 PHF 06 SS	Ø6 - 1/4	12	56	-	-
6	R355 00 103	461.06 PHF 08 SS	Ø8 - 5/16	12	56	-	-
6	R355 00 104	461.06 PHF 10 SS	Ø10 - 3/8	13	56	-	-
6	R355 00 105	461.06 PHF 13 SS	Ø13 - 1/2	16.5	60	-	-

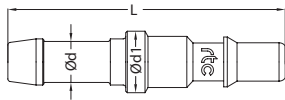

*SS: Stainless Steel / Edelstahl



Male thread plug with valve / Verschlussnippel mit Aussengewinde

TYPE 450.06



Plug / Nippel

Size / Größe	Alternative Order No Alternative Bestellnr.	Order No / Bestellnr.	Ød	Ød1	L	L1	HEX.
6	R253 00 171	461.06 PMB 13	BSP 1/4	-	70	60	17
6	R253 00 172	461.06 PMB 17	BSP 3/8	-	70	60	19
6	-	461.06 PTB 13	NPT 1/4	-	72	60	17
6	R353 00 119	461.06 PMB 13 SS	BSP 1/4	-	70	60	17
6	R353 00 120	461.06 PMB 17 SS	BSP 3/8	-	70	60	19
6	R353 00 311	461.06 PTB 13 SS	NPT 1/4	-	72	60	17
6	R353 00 312	461.06 PTB 17 SS	NPT 3/8	-	73	60	19

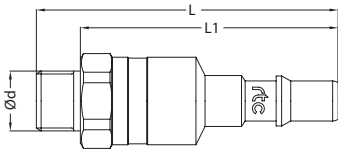

*SS: Stainless Steel / Edelstahl



Female thread plug with valve / Verschlussnippel mit Innengewinde

TYPE 450.06



Plug / Nippel

Size / Größe	Alternative Order No Alternative Bestellnr.	Order No / Bestellnr.	Ød	Ød1	L	L1	HEX.
6	R253 00 169	461.06 PFB 13	BSP 1/4	-	72	-	17
6	R253 00 170	461.06 PFB 17	BSP 3/8	-	72	-	22
6	-	461.06 PNB 13	NPT 1/4	-	72	-	17
6	R353 00 117	461.06 PFB 13 SS	BSP 1/4	-	72	-	17
6	R353 00 118	461.06 PFB 17 SS	BSP 3/8	-	72	-	22
6	R353 00 309	461.06 PNB 13 SS	NPT 1/4	-	72	-	17
6	R353 00 310	461.06 PNB 17 SS	NPT 3/8	-	72	-	22

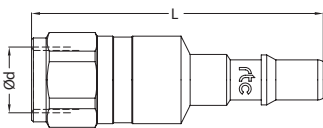

*SS: Stainless Steel / Edelstahl



Standard hose plug with valve / Verschlussnippel mit Schlauchanschluss

TYPE 450.06



Plug / Nippel

Size / Größe	Alternative Order No Alternative Bestellnr.	Order No / Bestellnr.	Ød	Ød1	L	L1	HEX.
6	R253 00 173	461.06 PHB 06	Ø6 - 1/4	-	79	-	17
6	R253 00 174	461.06 PHB 08	Ø8 - 5/16	-	79	-	17
6	R253 00 175	461.06 PHB 10	Ø10 - 3/8	-	79	-	17
6	R353 00 121	461.06 PHB 06 SS	Ø6 - 1/4	-	79	-	17
6	R353 00 122	461.06 PHB 08 SS	Ø8 - 5/16	-	79	-	17
6	R353 00 123	461.06 PHB 10 SS	Ø10 - 3/8	-	79	-	17
6	R353 00 313	461.06 PHB 13 SS	Ø13 - 1/2	-	82	-	17

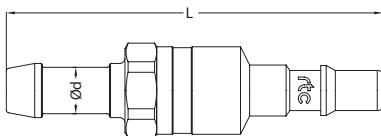

*SS: Stainless Steel / Edelstahl



rtc[®]

QUICK CONNECT TECHNOLOGY
www.rtc-tec.com

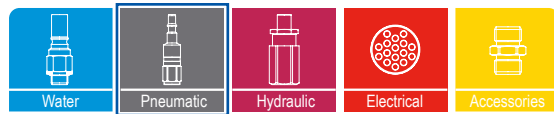

451.08

rtc TYPE





Compatible - Kompatibilität

rtc	170.08
rtc	171.08
rtc	173.08
rtc	450.08
rtc	461.08 / SC-E1

Temperature Range - Temperaturbereich

Nitrile (N)	-20°C + 110°C (- 4°F + 230°F)
FPM (V)	-20°C + 180°C (- 4°F + 356°F)
EPDM (Ethylene Propylene)	-40°C + 150°C (- 40°F + 302°F)

Working Pressure - Betriebsdruck

25 Bar (360 PSI)

Connction / Disconnection Max. Pressure -

Ein- und Auskuppelbar bis Max. Druck
15 Bar (220 PSI)

Flow size - Nennweite

rtc type 451.08 8mm (3/8")

Standard version - Standardversion

Seals - Dichtung : Nitrile (N)

Material of standard version with plastic release ring

Material für die Standardversion mit Kunststoffauslösering

Socket Body -	Steel tenifer threaded
Kupplungsgrundkörper	Stahl teneferiert
Back Part -	Steel zinc nickel plated
Hinterteil	Stahl Zink-Nickel beschichtet
Sleeve -	Orange colour plastic
Hülse	Kunststoff, Farbe orange
Springs - Federn	Stainless steel - Edelstahl
Seals - Dichtungen	Nitrile (N)

Plug	Steel tenifer threaded
Nippel	Stahl teneferiert

Advantages

- The system perfectly fits to the **ISO 4414, EN 983** safety requirements.
- Plug profile perfectly fits to the **ISO 6150-C-14, AFNOR C-14 NF E 49-053**
- 2 stage disconnection safety feature
- Through flow, minimum pressure loss
- Negligible Connecting Force
- Smart and Ergonomic features
- Ease of Handling
- Optimised Size

Vorteil

- Sicherheit gemäß **ISO 4414, EN 983**
- Stecknippel gemäß **ISO 6150-C-14, AFNOR C-14 NF E 49-053**
- 2 stufen Sicherheitsentriegelung
- Voller Durchgang, sehr geringer Druckverlust
- Einfache Bedienung, sehr geringe Kuppelkraft
- Kompakte Bauform



Flow Rate vs Pressure Drop Graph

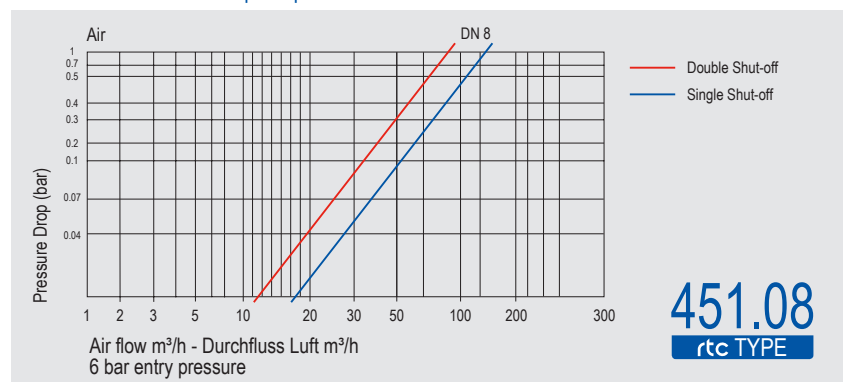

rtc TYPE 451.08

Plastic sleeve socket with male thread / Kupplung mit Kunststoffdrehhülse und Aussengewinde



Socket / Kupplung

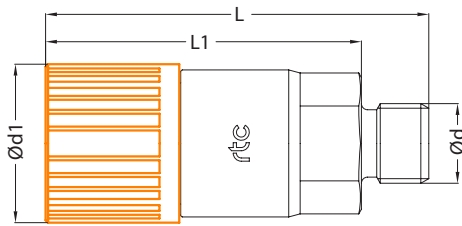

Size / Größe	Alternative Order No Alternative Bestellnr.	Order No / Bestellnr.	Ød	Ød1	L	L1	HEX.
8	R203 00 299	451.08 SMB 17	BSP 3/8	32	73	63	24
8	R203 00 300	451.08 SMB 21	BSP 1/2	32	75	63	24
8	-	451.08 STB 17	NPT 3/8	32	75	63	24
8	-	451.08 STB 21	NPT 1/2	32	80	63	24

rtc TYPE 451.08

Plastic sleeve socket with female thread / Kupplung mit Kunststoffdrehhülse und Innengewinde



Socket / Kupplung

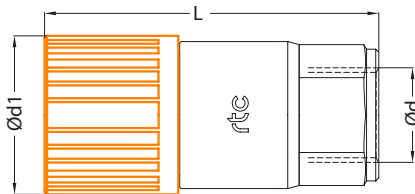

Size / Größe	Alternative Order No Alternative Bestellnr.	Order No / Bestellnr.	Ød	Ød1	L	L1	HEX.
8	R203 00 295	451.08 SFB 13	BSP 1/4	32	73	-	24
8	R203 00 296	451.08 SFB 17	BSP 3/8	32	73	-	24
8	R203 00 297	451.08 SFB 21	BSP 1/2	32	76	-	24
8	-	451.08 SNB 17	NPT 3/8	32	74	-	24
8	-	451.08 SNB 21	NPT 1/2	32	81	-	24

rtc TYPE 451.08

Plastic sleeve standard hose socket / Kupplung mit Kunststoffdrehhülse und Schlauchanschluss



Socket / Kupplung

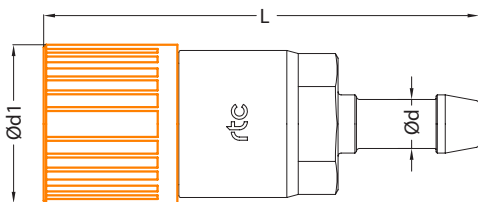

Size / Größe	Alternative Order No Alternative Bestellnr.	Order No / Bestellnr.	Ød	Ød1	L	L1	HEX.
8	R203 00 302	451.08 SHB 08	Ø8 - 5/16	32	84	-	-
8	R203 00 303	451.08 SHB 10	Ø10 - 3/8	32	87	-	-
8	R203 00 304	451.08 SHB 13	Ø13 - 1/2	32	87	-	-

rtc TYPE 451.08

Male thread plug / Nippel mit Aussengewinde



Plug / Nippel

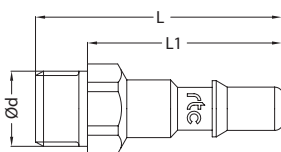

Size / Größe	Alternative Order No Alternative Bestellnr.	Order No / Bestellnr.	Ød	Ød1	L	L1	HEX.
8	R255 00 101	461.08 PMF 13	BSP 1/4	-	55	44	17
8	R255 00 102	461.08 PMF 17	BSP 3/8	-	57	44.5	19
8	-	461.08 PMF 21	BSP 1/2	-	60	48	24
8	R255 00 090	461.08 PTF 13	NPT 1/4	-	57	44.5	17
8	R255 00 089	461.08 PTF 17	NPT 3/8	-	57	44.5	19
8	R355 00 090	461.08 PMF 13 SS	BSP 1/4	-	55	44	17
8	R355 00 091	461.08 PMF 17 SS	BSP 3/8	-	57	44.5	19
8	-	461.08 PMF 21 SS	BSP 1/2	-	60	48	24
8	R355 00 092	461.08 PTF 13 SS	NPT 1/4	-	57	44.5	17
8	R355 00 093	461.08 PTF 17 SS	NPT 3/8	-	57	44.5	19

*SS: Stainless Steel / Edelstahl

Female thread plug / Nippel mit Innengewinde TYPE 451.08 

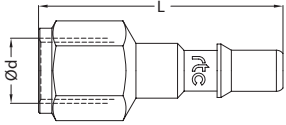
Plug / Nippel	Size / Größe	Alternative Order No Alternative Bestellnr.	Order No / Bestellnr.	Ød	Ød1	L	L1	HEX.
	8	R255 00 103	461.08 PFF 13	BSP 1/4	-	55.5	-	17
	8	R255 00 105	461.08 PFF 17	BSP 3/8	-	57.5	-	22
	8	-	461.08 PFF 21	BSP 1/2	-	59	-	27
	8	R255 00 104	461.08 PNF 13	NPT 1/4	-	56.5	-	17
	8	R255 00 106	461.08 PNF 17	NPT 3/8	-	57.5	-	22
	8	-	461.08 PNF 21	NPT 1/2	-	61	-	27
	8	R355 00 088	461.06 PFF 13 SS	BSP 1/4	-	55.5	-	17
	8	R355 00 089	461.06 PFF 17 SS	BSP 3/8	-	57.5	-	22
	8	-	461.06 PFF 21 SS	BSP 1/2	-	59	-	27
	8	R355 00 094	461.06 PNF 13 SS	NPT 1/4	-	56.5	-	17
	8	R355 00 095	461.06 PNF 17 SS	NPT 3/8	-	57.5	-	22
	8	R355 00 359	461.06 PNF 21 SS	NPT 1/2	-	61	-	27

*SS: Stainless Steel / Edelstahl

Standard hose plug / Nippel mit Schlauchanschluss TYPE 451.08 

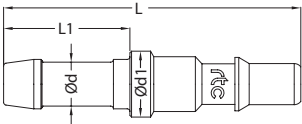
Plug / Nippel	Size / Größe	Alternative Order No Alternative Bestellnr.	Order No / Bestellnr.	Ød	Ød1	L	L1	HEX.
	8	R255 00 107	461.08 PHF 08	Ø8 - 5/16	15	62	-	-
	8	R255 00 108	461.08 PHF 10	Ø10 - 3/8	15	62	-	-
	8	R255 00 109	461.08 PHF 13	Ø13 - 1/2	17	66	-	-
	8	R255 00 110	461.08 PHF 16	Ø16 - 5/8	19	66	-	-
	8	R355 00 611	461.08 PHF 08 SS	Ø8 - 5/16	15	62	-	-
	8	R355 00 612	461.08 PHF 10 SS	Ø10 - 3/8	15	62	-	-
	8	R355 00 613	461.08 PHF 13 SS	Ø13 - 1/2	17	66	-	-
	8	R355 00 614	461.08 PHF 16 SS	Ø16 - 5/8	19	66	-	-

*SS: Stainless Steel / Edelstahl

Male thread plug with valve / Verschlussnippel mit Aussengewinde TYPE 451.08 

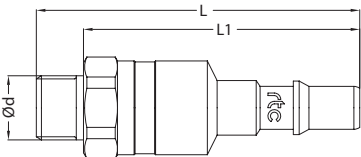
Plug / Nippel	Size / Größe	Alternative Order No Alternative Bestellnr.	Order No / Bestellnr.	Ød	Ød1	L	L1	HEX.
	8	R253 00 159	461.08 PMB 17	BSP 3/8	-	86	74	24
	8	-	461.08 PMB 21	BSP 1/2	-	88	74	24
	8	-	461.08 PTB 17	NPT 3/8	-	88	74	24
	8	R353 00 102	461.08 PMB 17 SS	BSP 3/8	-	86	74	24
	8	-	461.08 PMB 21 SS	BSP 1/2	-	88	74	24
	8	R353 00 315	461.08 PTB 17 SS	NPT 3/8	-	88	74	24

*SS: Stainless Steel / Edelstahl

Female thread plug with valve / Verschlussnippel mit Innengewinde TYPE 451.08 

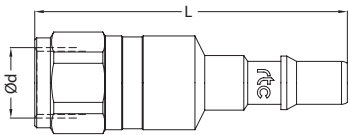
Plug / Nippel	Size / Größe	Alternative Order No Alternative Bestellnr.	Order No / Bestellnr.	Ød	Ød1	L	L1	HEX.
	8	R253 00 157	461.08 PFB 17	BSP 3/8	-	80	-	24
	8	-	461.08 PFB 21	BSP 1/2	-	82	-	24
	8	-	461.08 PNB 17	NPT 3/8	-	80	-	24
	8	R353 00 100	461.08 PFB 17 SS	BSP 3/8	-	80	-	24
	8	-	461.08 PFB 21 SS	BSP 1/2	-	82	-	24
	8	R353 00 314	461.08 PNB 17 SS	NPT 3/8	-	80	-	24

*SS: Stainless Steel / Edelstahl

Standard hose plug with valve / Verschlussnippel mit Schlauchanschluss TYPE 451.08 

Plug / Nippel	Size / Größe	Alternative Order No Alternative Bestellnr.	Order No / Bestellnr.	Ød	Ød1	L	L1	HEX.
	8	R253 00 161	461.08 PHB 10	Ø10 - 3/8	-	97	-	24
	8	R253 00 163	461.08 PHB 13	Ø13 - 1/2	-	100	-	24
	8	R353 00 104	461.08 PHB 10 SS	Ø10 - 3/8	-	97	-	24
	8	R353 00 106	461.08 PHB 13 SS	Ø13 - 1/2	-	100	-	24

*SS: Stainless Steel / Edelstahl

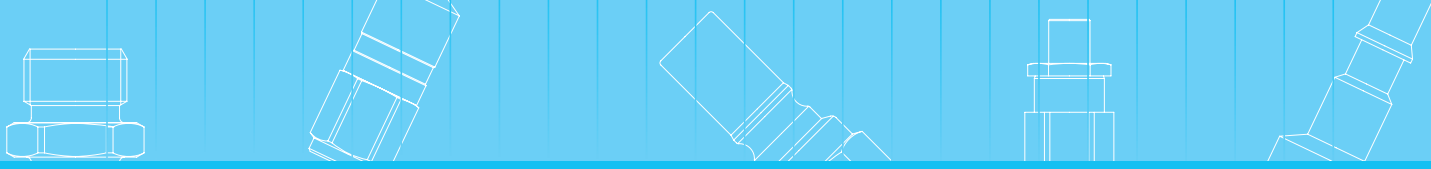

rtc[®]

QUICK CONNECT TECHNOLOGY
www.rtc-tec.com



452.06

rtc TYPE





Temperature Range - Temperaturbereich

Nitrile (N)	-20°C + 110°C (- 4°F + 230°F)
FPM (V)	-20°C + 180°C (- 4°F + 356°F)
EPDM (Ethylene Propylene)	-40°C + 150°C (- 40°F + 302°F)

Working Pressure - Betriebsdruck

25 Bar (360 PSI)

Connction / Disconnection Pressure -

15 Bar (220 PSI)

Flow size - Nennweite

rtc type 452.06 5.5mm (1/4")

Standard version - Standardversion

Seals - Dichtung : Nitrile (N)

Material of stainless the steel version

Material für die Edelstahlversion

Socket Body - Kupplungsgrundkörper	Stainless steel Edelstahl
Back Part - Hinterteil	Stainless steel - Edelstahl
Sleeve - Hülse	Stainless steel - Edelstahl
Springs - Federn	Stainless steel - Edelstahl
Seals - Dichtungen	FPM (V)

Plug - Nippel Stainless steel - Edelstahl

Material of steel version / Material für die Stahl Version

Socket Body - Kupplungsgrundkörper	Steel tenifer threaded Stahl teneferiert
Back Part - Hinterteil	Steel zinc nickel plated Stahl Zink-Nickel beschichtet
Sleeve -	Steel zinc nickel plated and painted Stahl Zink-Nickel beschichtet farbig Lackiert - je nach Kodierung
Hülse	Stainless steel - Edelstahl
Springs - Federn	Stainless steel - Edelstahl
Seals - Dichtungen	Nitrile (N)

Plug - Nippel Stainless steel - Edelstahl

Advantages

- The system perfectly fits to the ISO 4414, EN 983 safety requirements.
- Plug profile perfectly fits to the ISO 6150-C-10, AFNOR C-10 NF E 49-053
- 2 stage disconnection safety feature
- Through flow, minimum pressure loss
- Negligible Connecting Force
- Smart and Ergonomic features
- Ease of Handling
- Optimised Size

Vorteil

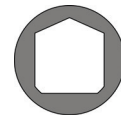
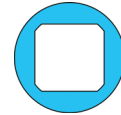

- Sicherheit gemäß ISO 4414, EN 983
- Stecknippel gemäß ISO 6150-C-10, AFNOR C-10 NF E 49-053
- 2 stufen Sicherheitsentriegelung
- Voller Durchgang, sehr geringer Druckverlust
- Einfache Bedienung, sehr geringe Kuppelkraft
- Kompakte Bauform

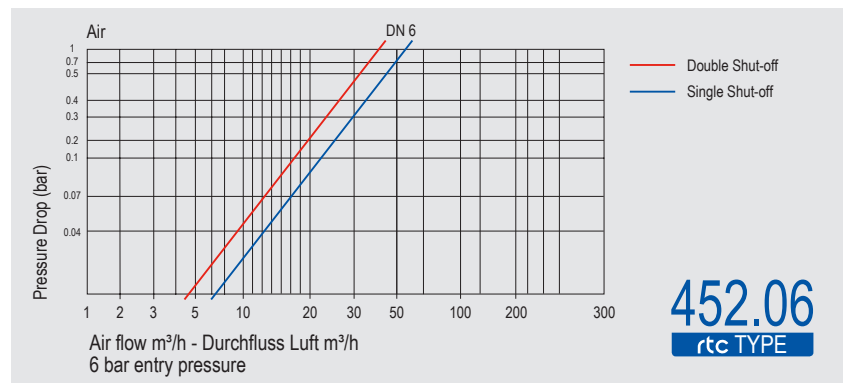

Flow Rate vs Pressure Drop Graph



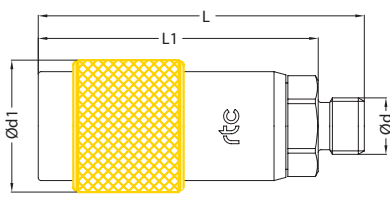

rtc TYPE 452.06 Two faces coded male thread socket / Zwei Seiten Rund kodierte Kupplung mit Aussengewinde

Socket / Kupplung	Size / Größe	Alternative Order No Alternative Bestellnr.	Order No / Bestellnr.	Ød	Ød1	L	L1	HEX.
 	6	R303 00 375	452.06 SMB 213 SS/Y	BSP 1/4	28	61.5	52	22
	6	R303 00 376	452.06 SMB 217 SS/Y	BSP 3/8	28	61.5	52	22
	6	R303 00 652	452.06 SMB 221 SS/Y	BSP 1/2	28	67.5	52	22
	6	R303 00 490	452.06 STB 213 SS/Y	NPT 1/4	28	62.5	52	22
	6	R303 00 653	452.06 STB 217 SS/Y	NPT 3/8	28	62.5	52	22
	6	R303 00 720	452.06 SMB 213 SS	BSP 1/4	28	61.5	52	22
	6	R303 00 721	452.06 SMB 217 SS	BSP 3/8	28	61.5	52	22
	6	R303 00 722	452.06 SMB 221 SS	BSP 1/2	28	67.5	52	22
	6	R303 00 723	452.06 STB 213 SS	NPT 1/4	28	62.5	52	22
	6	R303 00 724	452.06 STB 217 SS	NPT 3/8	28	62.5	52	22
	6	R203 00 403	452.06 SMB 213	BSP 1/4	28	61.5	52	22
	6	R203 00 404	452.06 SMB 217	BSP 3/8	28	61.5	52	22
	6	-	452.06 STB 213	NPT 1/4	28	62.5	52	22
	6	-	452.06 STB 217	NPT 3/8	28	62.5	52	22

*SS: Stainless Steel / Edelstahl (Colourless / Farblos)
Y: Yellow / Gelb (Coloured / Farbig)

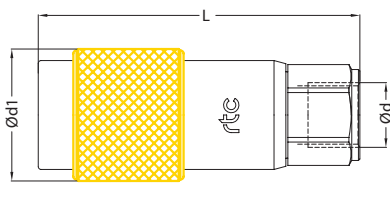
rtc TYPE 452.06 Two faces coded female thread socket / Zwei Seiten Rund kodierte Kupplung mit Innengewinde

Socket / Kupplung	Size / Größe	Alternative Order No Alternative Bestellnr.	Order No / Bestellnr.	Ød	Ød1	L	L1	HEX.
 	6	R303 00 650	452.06 SFB 210 SS/Y	BSP 1/8	28	56	-	22
	6	R303 00 372	452.06 SFB 213 SS/Y	BSP 1/4	28	56	-	22
	6	R303 00 373	452.06 SFB 217 SS/Y	BSP 3/8	28	64.5	-	22
	6	R303 00 374	452.06 SFB 221 SS/Y	BSP 1/2	28	66.5	-	24
	6	R303 00 489	452.06 SNB 213 SS/Y	NPT 1/4	28	56	-	22
	6	R303 00 651	452.06 SNB 217 SS/Y	NPT 3/8	28	64.5	-	22
	6	R303 00 714	452.06 SFB 210 SS	BSP 1/8	28	56	-	22
	6	R303 00 715	452.06 SFB 213 SS	BSP 1/4	28	56	-	22
	6	R303 00 716	452.06 SFB 217 SS	BSP 3/8	28	64.5	-	22
	6	R303 00 717	452.06 SFB 221 SS	BSP 1/2	28	66.5	-	24
	6	R303 00 718	452.06 SNB 213 SS	NPT 1/4	28	56	-	22
	6	R303 00 719	452.06 SNB 217 SS	NPT 3/8	28	64.5	-	22
	6	R203 00 400	451.06 SFB 213	BSP 1/4	28	56	-	22
	6	R203 00 401	451.06 SFB 217	BSP 3/8	28	64.5	-	22
	6	R203 00 402	451.06 SFB 221	BSP 1/2	28	66.5	-	24
	6	-	451.06 SNB 213	NPT 1/4	28	56	-	22
	6	-	451.06 SNB 217	NPT 3/8	28	64.5	-	22

*SS: Stainless Steel / Edelstahl (Colourless / Farblos)
Y: Yellow / Gelb (Coloured / Farbig)

rtc TYPE 452.06 Two faces coded standard hose socket / Zwei Seiten Rund kodierte Kupplung mit Schlauchanschluss

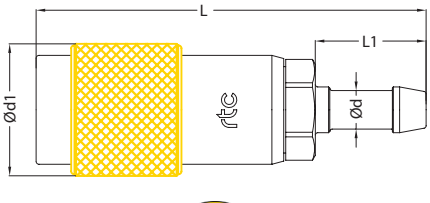
Socket / Kupplung	Size / Größe	Alternative Order No Alternative Bestellnr.	Order No / Bestellnr.	Ød	Ød1	L	L1	HEX.
 	6	R303 00 377	452.06 SHB 206 SS/Y	Ø6 - 1/4	28	74.5	23	-
	6	R303 00 378	452.06 SHB 208 SS/Y	Ø8 - 5/16	28	74.5	23	-
	6	R303 00 379	452.06 SHB 210 SS/Y	Ø10 - 3/8	28	74.5	23	-
	6	R303 00 654	452.06 SHB 213 SS/Y	Ø13 - 1/2	28	74.5	23	-
	6	R303 00 725	452.06 SHB 206 SS	Ø6 - 1/4	28	74.5	23	-
	6	R303 00 726	452.06 SHB 208 SS	Ø8 - 5/16	28	74.5	23	-
	6	R303 00 727	452.06 SHB 210 SS	Ø10 - 3/8	28	74.5	23	-
	6	R303 00 728	452.06 SHB 213 SS	Ø13 - 1/2	28	74.5	23	-
	6	R203 00 405	452.06 SHB 206	Ø6 - 1/4	28	74.5	23	-
	6	R203 00 406	452.06 SHB 208	Ø8 - 5/16	28	74.5	23	-
	6	R203 00 407	452.06 SHB 210	Ø10 - 3/8	28	74.5	23	-
	6	-	452.06 SHB 213	Ø13 - 1/2	28	74.5	23	-

*SS: Stainless Steel / Edelstahl (Colourless / Farblos)
Y: Yellow / Gelb (Coloured / Farbig)



Two faces coded male thread plug / Zwei Seiten Rund kodierter Nippel mit Aussengewinde

TYPE 452.06 

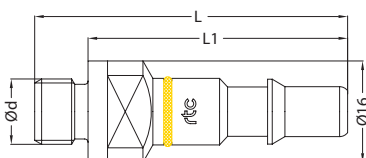
Plug / Nippel	Size / Größe	Alternative Order No Alternative Bestellnr.	Order No / Bestellnr.	Ød	Ød1	L	L1	HEX.
 <p>*SS: Stainless Steel / Edelstahl (Colourless / Farblos) Y: Yellow / Gelb (Coloured / Farbig)</p>	6	R355 00 286	452.06 PMF 210 SS/Y	BSP 1/8	-	44	36	17
	6	R355 00 287	452.06 PMF 213 SS/Y	BSP 1/4	-	47	36	17
	6	R355 00 344	452.06 PTF 213 SS/Y	NPT 1/4	-	47	36	17
	6	R390 00 295	452.06 PMF 210 SS	BSP 1/8	-	44	36	17
	6	R390 00 296	452.06 PMF 213 SS	BSP 1/4	-	47	36	17
	6	R390 00 365	452.06 PTF 213 SS	NPT 1/4	-	47	36	17



Two faces coded standard hose plug / Zwei Seiten Rund kodierter Nippel mit Schlauchanschluss

TYPE 452.06 

Plug / Nippel	Size / Größe	Alternative Order No Alternative Bestellnr.	Order No / Bestellnr.	Ød	Ød1	L	L1	HEX.
 <p>*SS: Stainless Steel / Edelstahl (Colourless / Farblos) Y: Yellow / Gelb (Coloured / Farbig)</p>	6	R355 00 288	452.06 PHF 206 SS/Y	Ø6 - 1/4	-	55.5	23	-
	6	R355 00 289	452.06 PHF 208 SS/Y	Ø8 - 5/16	-	55.5	23	-
	6	R355 00 290	452.06 PHF 210 SS/Y	Ø10 - 3/8	-	55.5	23	-
	6	R390 00 297	452.06 PHF 206 SS	Ø6 - 1/4	-	55.5	23	-
	6	R390 00 298	452.06 PHF 208 SS	Ø8 - 5/16	-	55.5	23	-
	6	R390 00 299	452.06 PHF 210 SS	Ø10 - 3/8	-	55.5	23	-



Two faces coded male thread plug with valve / Zwei Seiten Rund kodierter Verschlussnippel mit Aussengewinde

TYPE 452.06 

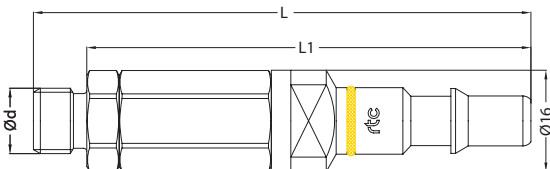
Plug / Nippel	Size / Größe	Alternative Order No Alternative Bestellnr.	Order No / Bestellnr.	Ød	L	L1	HEX.
 <p>*SS: Stainless Steel / Edelstahl (Colourless / Farblos) Y: Yellow / Gelb (Coloured / Farbig)</p>	6	R353 00 241	452.06 PMB 213 SS/Y	BSP 1/4	90	79	17
	6	R353 00 242	452.06 PMB 217 SS/Y	BSP 3/8	90	79	19
	6	R353 00 299	452.06 PTB 213 SS/Y	NPT 1/4	91	79	17
	6	R353 00 300	452.06 PTB 217 SS/Y	NPT 3/8	91	79	19
	6	R353 00 356	452.06 PMB 213 SS	BSP 1/4	90	79	17
	6	R353 00 364	452.06 PMB 217 SS	BSP 3/8	90	79	19
	6	R353 00 384	452.06 PTB 213 SS	NPT 1/4	91	79	17
	6	R353 00 392	452.06 PTB 217 SS	NPT 3/8	91	79	19



Two faces coded female thread plug with valve / Zwei Seiten Rund kodierter Verschlussnippel mit Innengewinde

TYPE 452.06 

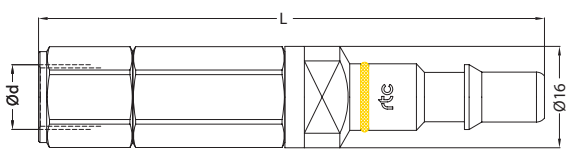
Plug / Nippel	Size / Größe	Alternative Order No Alternative Bestellnr.	Order No / Bestellnr.	Ød	L	L1	HEX.
 <p>*SS: Stainless Steel / Edelstahl (Colourless / Farblos) Y: Yellow / Gelb (Coloured / Farbig)</p>	6	R353 00 239	452.06 PFB 213 SS/Y	BSP 1/4	90	-	17
	6	R353 00 240	452.06 PFB 217 SS/Y	BSP 3/8	90	-	19
	6	R353 00 297	452.06 PNB 213 SS/Y	NPT 1/4	90	-	17
	6	R353 00 298	452.06 PNB 217 SS/Y	NPT 3/8	90	-	19
	6	R353 00 360	452.06 PFB 213 SS	BSP 1/4	90	-	17
	6	R353 00 368	452.06 PFB 217 SS	BSP 3/8	90	-	19
	6	R353 00 388	452.06 PNB 213 SS	NPT 1/4	90	-	17
	6	R353 00 396	452.06 PNB 217 SS	NPT 3/8	90	-	19



Two faces coded standard hose plug with valve / Zwei Seiten Rund kodierter Verschlussnippel mit Schlauchanschluss

TYPE 452.06 

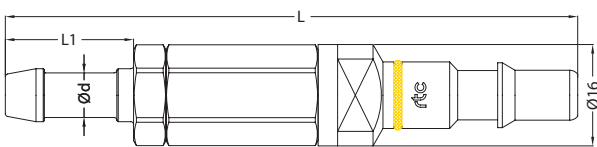
Plug / Nippel	Size / Größe	Alternative Order No Alternative Bestellnr.	Order No / Bestellnr.	Ød	Ød1	L	L1
 <p>*SS: Stainless Steel / Edelstahl (Colourless / Farblos) Y: Yellow / Gelb (Coloured / Farbig)</p>	6	R353 00 243	452.06 PHB 206 SS/Y	Ø6 - 1/4	-	100	23
	6	R353 00 244	452.06 PHB 208 SS/Y	Ø8 - 5/16	-	100	23
	6	R353 00 245	452.06 PHB 210 SS/Y	Ø10 - 3/8	-	100	23
	6	R353 00 376	452.06 PHB 206 SS	Ø6 - 1/4	-	100	23
	6	R353 00 380	452.06 PHB 208 SS	Ø8 - 5/16	-	100	23
	6	R353 00 372	452.06 PHB 210 SS	Ø10 - 3/8	-	100	23

rtc TYPE 452.06

Triangle coded male thread socket / Dreieck kodierte Kupplung mit Aussengewinde



Socket / Kupplung

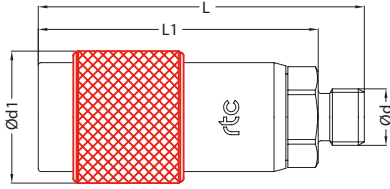

*SS: Stainless Steel / Edelstahl (Colourless / Farblos)
R: Red / Rot (Coloured / Farbig)

Size / Größe	Alternative Order No Alternative Bestellnr.	Order No / Bestellnr.	Ød	Ød1	L	L1	HEX.
6	R303 00 391	452.06 SMB 313 SS/R	BSP 1/4	28	61.5	52	22
6	R303 00 392	452.06 SMB 317 SS/R	BSP 3/8	28	61.5	52	22
6	R303 00 647	452.06 SMB 321 SS/R	BSP 1/2	28	67.5	52	22
6	R303 00 488	452.06 STB 313 SS/R	NPT 1/4	28	62.5	52	22
6	R303 00 648	452.06 STB 317 SS/R	NPT 3/8	28	62.5	52	22
6	R303 00 735	452.06 SMB 313 SS	BSP 1/4	28	61.5	52	22
6	R303 00 736	452.06 SMB 317 SS	BSP 3/8	28	61.5	52	22
6	R303 00 737	452.06 SMB 321 SS	BSP 1/2	28	67.5	52	22
6	R303 00 738	452.06 STB 313 SS	NPT 1/4	28	62.5	52	22
6	R303 00 739	452.06 STB 317 SS	NPT 3/8	28	62.5	52	22
6	R203 00 419	452.06 SMB 313	BSP 1/4	28	61.5	52	22
6	R203 00 420	452.06 SMB 317	BSP 3/8	28	61.5	52	22
6	-	452.06 STB 313	NPT 1/4	28	62.5	52	22
6	-	452.06 STB 317	NPT 3/8	28	62.5	52	22

rtc TYPE 452.06

Triangle coded female thread socket / Dreieck kodierte Kupplung mit Innengewinde



Socket / Kupplung

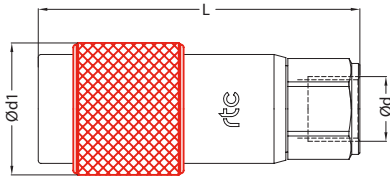

*SS: Stainless Steel / Edelstahl (Colourless / Farblos)
R: Red / Rot (Coloured / Farbig)

Size / Größe	Alternative Order No Alternative Bestellnr.	Order No / Bestellnr.	Ød	Ød1	L	L1	HEX.
6	R303 00 645	452.06 SFB 310 SS/R	BSP 1/8	28	56	-	22
6	R303 00 388	452.06 SFB 313 SS/R	BSP 1/4	28	56	-	22
6	R303 00 389	452.06 SFB 317 SS/R	BSP 3/8	28	64.5	-	22
6	R303 00 390	452.06 SFB 321 SS/R	BSP 1/2	28	66.5	-	24
6	R303 00 487	452.06 SNB 313 SS/R	NPT 1/4	28	56	-	22
6	R303 00 646	452.06 SNB 317 SS/R	NPT 3/8	28	64.5	-	22
6	R303 00 729	452.06 SFB 310 SS	BSP 1/8	28	56	-	22
6	R303 00 730	452.06 SFB 313 SS	BSP 1/4	28	56	-	22
6	R303 00 731	452.06 SFB 317 SS	BSP 3/8	28	64.5	-	22
6	R303 00 732	452.06 SFB 321 SS	BSP 1/2	28	66.5	-	24
6	R303 00 733	452.06 SNB 313 SS	NPT 1/4	28	56	-	22
6	R303 00 734	452.06 SNB 317 SS	NPT 3/8	28	64.5	-	22
6	R203 00 416	451.06 SFB 313	BSP 1/4	28	56	-	22
6	R203 00 417	451.06 SFB 317	BSP 3/8	28	64.5	-	22
6	R203 00 418	451.06 SFB 321	BSP 1/2	28	66.5	-	24
6	-	451.06 SNB 313	NPT 1/4	28	56	-	22
6	-	451.06 SNB 317	NPT 3/8	28	64.5	-	22

rtc TYPE 452.06

Triangle coded standard hose socket / Dreieck kodierte Kupplung mit Schlauchanschluss



Socket / Kupplung

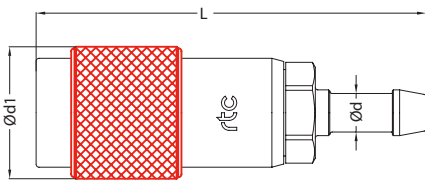

*SS: Stainless Steel / Edelstahl (Colourless / Farblos)
R: Red / Rot (Coloured / Farbig)

Size / Größe	Alternative Order No Alternative Bestellnr.	Order No / Bestellnr.	Ød	Ød1	L	L1	HEX.
6	R303 00 393	452.06 SHB 306 SS/R	Ø6 - 1/4	28	74.5	23	-
6	R303 00 394	452.06 SHB 308 SS/R	Ø8 - 5/16	28	74.5	23	-
6	R303 00 395	452.06 SHB 310 SS/R	Ø10 - 3/8	28	74.5	23	-
6	R303 00 649	452.06 SHB 313 SS/R	Ø13 - 1/2	28	74.5	23	-
6	R303 00 740	452.06 SHB 306 SS	Ø6 - 1/4	28	74.5	23	-
6	R303 00 741	452.06 SHB 308 SS	Ø8 - 5/16	28	74.5	23	-
6	R303 00 742	452.06 SHB 310 SS	Ø10 - 3/8	28	74.5	23	-
6	R303 00 743	452.06 SHB 313 SS	Ø13 - 1/2	28	74.5	23	-
6	R203 00 421	452.06 SHB 306	Ø6 - 1/4	28	74.5	23	-
6	R203 00 422	452.06 SHB 308	Ø8 - 5/16	28	74.5	23	-
6	R203 00 423	452.06 SHB 310	Ø10 - 3/8	28	74.5	23	-
6	-	452.06 SHB 313	Ø13 - 1/2	28	74.5	23	-

Triangle coded male thread plug / Dreieck kodierter Nippel mit Aussengewinde TYPE 452.06 

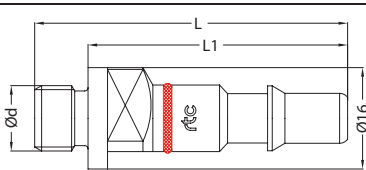
Plug / Nippel	Size / Größe	Alternative Order No Alternative Bestellnr.	Order No / Bestellnr.	Ød	Ød1	L	L1	HEX.
 <p>*SS: Stainless Steel / Edelstahl (Colourless / Farblos) R: Red / Rot (Coloured / Farbig)</p>	6	R355 00 296	452.06 PMF 310 SS/R	BSP 1/8	-	44	36	17
	6	R355 00 297	452.06 PMF 313 SS/R	BSP 1/4	-	47	36	17
	6	R355 00 343	452.06 PTF 313 SS/R	NPT 1/4	-	47	36	17
	6	R390 00 305	452.06 PMF 310 SS	BSP 1/8	-	44	36	17
	6	R390 00 306	452.06 PMF 313 SS	BSP 1/4	-	47	36	17
	6	R390 00 364	452.06 PTF 313 SS	NPT 1/4	-	47	36	17

Triangle coded standard hose plug / Dreieck kodierter Nippel mit Schlauchanschluss TYPE 452.06 

Plug / Nippel	Size / Größe	Alternative Order No Alternative Bestellnr.	Order No / Bestellnr.	Ød	Ød1	L	L1	HEX.
 <p>*SS: Stainless Steel / Edelstahl (Colourless / Farblos) R: Red / Rot (Coloured / Farbig)</p>	6	R355 00 298	452.06 PHF 306 SS/R	Ø6 - 1/4	-	55.5	23	-
	6	R355 00 299	452.06 PHF 308 SS/R	Ø8 - 5/16	-	55.5	23	-
	6	R355 00 300	452.06 PHF 310 SS/R	Ø10 - 3/8	-	55.5	23	-
	6	R390 00 307	452.06 PHF 306 SS	Ø6 - 1/4	-	55.5	23	-
	6	R390 00 308	452.06 PHF 308 SS	Ø8 - 5/16	-	55.5	23	-
	6	R390 00 309	452.06 PHF 310 SS	Ø10 - 3/8	-	55.5	23	-

Triangle coded male thread plug with valve / Dreieck kodierter Verschlussnippel mit Aussengewinde TYPE 452.06 

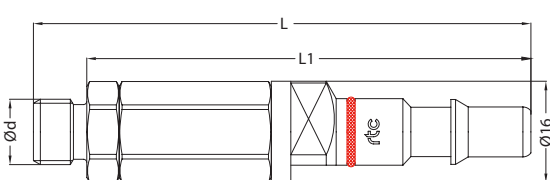
Plug / Nippel	Size / Größe	Alternative Order No Alternative Bestellnr.	Order No / Bestellnr.	Ød	L	L1	HEX.
 <p>*SS: Stainless Steel / Edelstahl (Colourless / Farblos) R: Red / Rot (Coloured / Farbig)</p>	6	R353 00 255	452.06 PMB 313 SS/R	BSP 1/4	90	79	17
	6	R353 00 256	452.06 PMB 317 SS/R	BSP 3/8	90	79	19
	6	R353 00 295	452.06 PTB 313 SS/R	NPT 1/4	91	79	17
	6	R353 00 296	452.06 PTB 317 SS/R	NPT 3/8	91	79	19
	6	R353 00 355	452.06 PMB 313 SS	BSP 1/4	90	79	17
	6	R353 00 363	452.06 PMB 317 SS	BSP 3/8	90	79	19
	6	R353 00 387	452.06 PTB 313 SS	NPT 1/4	91	79	17
	6	R353 00 391	452.06 PTB 317 SS	NPT 3/8	91	79	19

Triangle coded female thread plug with valve / Dreieck kodierter Verschlussnippel mit Innengewinde TYPE 452.06 

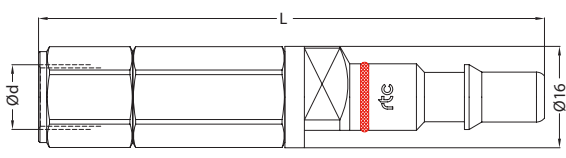
Plug / Nippel	Size / Größe	Alternative Order No Alternative Bestellnr.	Order No / Bestellnr.	Ød	L	L1	HEX.
 <p>*SS: Stainless Steel / Edelstahl (Colourless / Farblos) R: Red / Rot (Coloured / Farbig)</p>	6	R353 00 253	452.06 PFB 313 SS/R	BSP 1/4	90	-	17
	6	R353 00 254	452.06 PFB 317 SS/R	BSP 3/8	90	-	19
	6	R353 00 293	452.06 PNB 313 SS/R	NPT 1/4	90	-	17
	6	R353 00 294	452.06 PNB 317 SS/R	NPT 3/8	90	-	19
	6	R353 00 359	452.06 PFB 313 SS	BSP 1/4	90	-	17
	6	R353 00 367	452.06 PFB 317 SS	BSP 3/8	90	-	19
	6	R353 00 383	452.06 PNB 313 SS	NPT 1/4	90	-	17
	6	R353 00 395	452.06 PNB 317 SS	NPT 3/8	90	-	19

Triangle coded standard hose plug with valve / Dreieck kodierter Verschlussnippel mit Schlauchanschluss TYPE 452.06 

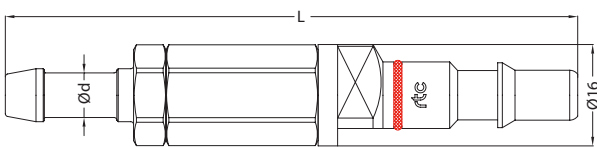
Plug / Nippel	Size / Größe	Alternative Order No Alternative Bestellnr.	Order No / Bestellnr.	Ød	Ød1	L	L1
 <p>*SS: Stainless Steel / Edelstahl (Colourless / Farblos) R: Red / Rot (Coloured / Farbig)</p>	6	R353 00 257	452.06 PHB 306 SS/R	Ø6 - 1/4	-	100	23
	6	R353 00 258	452.06 PHB 308 SS/R	Ø8 - 5/16	-	100	23
	6	R353 00 259	452.06 PHB 310 SS/R	Ø10 - 3/8	-	100	23
	6	R353 00 375	452.06 PHB 306 SS	Ø6 - 1/4	-	100	23
	6	R353 00 379	452.06 PHB 308 SS	Ø8 - 5/16	-	100	23
	6	R353 00 371	452.06 PHB 310 SS	Ø10 - 3/8	-	100	23

rtc TYPE 452.06

Square coded male thread socket / Viereck kodierte Kupplung mit Aussengewinde



Socket / Kupplung

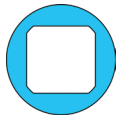
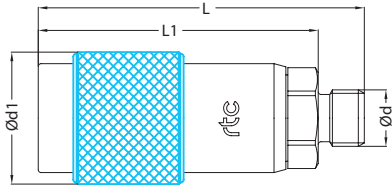

*SS: Stainless Steel / Edelstahl (Colourless / Farblos)
B: Blue / Blau (Coloured / Farbig)

Size / Größe	Alternative Order No Alternative Bestellnr.	Order No / Bestellnr.	Ød	Ød1	L	L1	HEX.
6	R303 00 383	452.06 SMB 413 SS/B	BSP 1/4	28	61.5	52	22
6	R303 00 384	452.06 SMB 417 SS/B	BSP 3/8	28	61.5	52	22
6	R303 00 662	452.06 SMB 421 SS/B	BSP 1/2	28	67.5	52	22
6	R303 00 494	452.06 STB 413 SS/B	NPT 1/4	28	62.5	52	22
6	R303 00 663	452.06 STB 417 SS/B	NPT 3/8	28	62.5	52	22
6	R303 00 705	452.06 SMB 413 SS	BSP 1/4	28	61.5	52	22
6	R303 00 706	452.06 SMB 417 SS	BSP 3/8	28	61.5	52	22
6	R303 00 707	452.06 SMB 421 SS	BSP 1/2	28	67.5	52	22
6	R303 00 708	452.06 STB 413 SS	NPT 1/4	28	62.5	52	22
6	R303 00 709	452.06 STB 417 SS	NPT 3/8	28	62.5	52	22
6	R203 00 411	452.06 SMB 413	BSP 1/4	28	61.5	52	22
6	R203 00 412	452.06 SMB 417	BSP 3/8	28	61.5	52	22
6	-	452.06 STB 413	NPT 1/4	28	62.5	52	22
6	-	452.06 STB 417	NPT 3/8	28	62.5	52	22

rtc TYPE 452.06

Square coded female thread socket / Viereck kodierte Kupplung mit Innengewinde



Socket / Kupplung

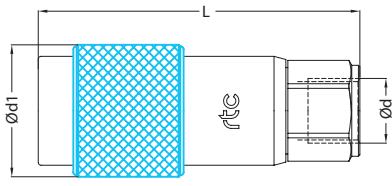

*SS: Stainless Steel / Edelstahl (Colourless / Farblos)
B: Blue / Blau (Coloured / Farbig)

Size / Größe	Alternative Order No Alternative Bestellnr.	Order No / Bestellnr.	Ød	Ød1	L	L1	HEX.
6	R303 00 660	452.06 SFB 410 SS/B	BSP 1/8	28	56	-	22
6	R303 00 380	452.06 SFB 413 SS/B	BSP 1/4	28	56	-	22
6	R303 00 381	452.06 SFB 417 SS/B	BSP 3/8	28	64.5	-	22
6	R303 00 382	452.06 SFB 421 SS/B	BSP 1/2	28	66.5	-	24
6	R303 00 493	452.06 SNB 413 SS/B	NPT 1/4	28	56	-	22
6	R303 00 661	452.06 SNB 417 SS/B	NPT 3/8	28	64.5	-	22
6	R303 00 699	452.06 SFB 410 SS	BSP 1/8	28	56	-	22
6	R303 00 700	452.06 SFB 413 SS	BSP 1/4	28	56	-	22
6	R303 00 701	452.06 SFB 417 SS	BSP 3/8	28	64.5	-	22
6	R303 00 702	452.06 SFB 421 SS	BSP 1/2	28	66.5	-	24
6	R303 00 703	452.06 SNB 413 SS	NPT 1/4	28	56	-	22
6	R303 00 704	452.06 SNB 417 SS	NPT 3/8	28	64.5	-	22
6	R203 00 408	451.06 SFB 413	BSP 1/4	28	56	-	22
6	R203 00 409	451.06 SFB 417	BSP 3/8	28	64.5	-	22
6	R203 00 410	451.06 SFB 421	BSP 1/2	28	66.5	-	24
6	-	451.06 SNB 413	NPT 1/4	28	56	-	22
6	-	451.06 SNB 417	NPT 3/8	28	64.5	-	22

rtc TYPE 452.06

Square coded standard hose socket / Viereck kodierte Kupplung mit Schlauchanschluss



Socket / Kupplung

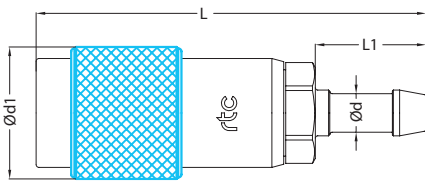

*SS: Stainless Steel / Edelstahl (Colourless / Farblos)
B: Blue / Blau (Coloured / Farbig)

Size / Größe	Alternative Order No Alternative Bestellnr.	Order No / Bestellnr.	Ød	Ød1	L	L1	HEX.
6	R303 00 385	452.06 SHB 406 SS/B	Ø6 - 1/4	28	74.5	23	-
6	R303 00 386	452.06 SHB 408 SS/B	Ø8 - 5/16	28	74.5	23	-
6	R303 00 387	452.06 SHB 410 SS/B	Ø10 - 3/8	28	74.5	23	-
6	R303 00 664	452.06 SHB 413 SS/B	Ø13 - 1/2	28	74.5	23	-
6	R303 00 710	452.06 SHB 406 SS	Ø6 - 1/4	28	74.5	23	-
6	R303 00 711	452.06 SHB 408 SS	Ø8 - 5/16	28	74.5	23	-
6	R303 00 712	452.06 SHB 410 SS	Ø10 - 3/8	28	74.5	23	-
6	R303 00 713	452.06 SHB 413 SS	Ø13 - 1/2	28	74.5	23	-
6	R203 00 413	452.06 SHB 406	Ø6 - 1/4	28	74.5	23	-
6	R203 00 414	452.06 SHB 408	Ø8 - 5/16	28	74.5	23	-
6	R203 00 415	452.06 SHB 410	Ø10 - 3/8	28	74.5	23	-
6	-	452.06 SHB 413	Ø13 - 1/2	28	74.5	23	-



Square coded male thread plug / Viereck kodierter Nippel mit Aussengewinde

TYPE 452.06 

Plug / Nippel	Size / Größe	Alternative Order No Alternative Bestellnr.	Order No / Bestellnr.	Ød	Ød1	L	L1	HEX.
 <p>*SS: Stainless Steel / Edelstahl (Colourless / Farblos) B: Blue / Blau (Coloured / Farbig)</p>	6	R355 00 291	452.06 PMB 410 SS/B	BSP 1/8	-	44	36	17
	6	R355 00 292	452.06 PMB 413 SS/B	BSP 1/4	-	47	36	17
	6	R355 00 346	452.06 PTB 413 SS/B	NPT 1/4	-	47	36	17
	6	R390 00 300	452.06 PMB 410 SS	BSP 1/8	-	44	36	17
	6	R390 00 301	452.06 PMB 413 SS	BSP 1/4	-	47	36	17
	6	R390 00 367	452.06 PTB 413-SS	NPT 1/4	-	47	36	17



Square coded standard hose plug / Viereck kodierter Nippel mit Schlauchanschluss

TYPE 452.06 

Plug / Nippel	Size / Größe	Alternative Order No Alternative Bestellnr.	Order No / Bestellnr.	Ød	Ød1	L	L1	HEX.
 <p>*SS: Stainless Steel / Edelstahl (Colourless / Farblos) B: Blue / Blau (Coloured / Farbig)</p>	6	R355 00 293	452.06 PHF 406 SS/B	Ø6 - 1/4	-	55.5	23	-
	6	R355 00 294	452.06 PHF 408 SS/B	Ø8 - 5/16	-	55.5	23	-
	6	R355 00 295	452.06 PHF 410 SS/B	Ø10 - 3/8	-	55.5	23	-
	6	R390 00 302	452.06 PHF 406 SS	Ø6 - 1/4	-	55.5	23	-
	6	R390 00 303	452.06 PHF 408 SS	Ø8 - 5/16	-	55.5	23	-
	6	R390 00 304	452.06 PHF 410 SS	Ø10 - 3/8	-	55.5	23	-



Square coded male thread plug with valve / Viereck kodierter Verschlussnippel mit Aussengewinde

TYPE 452.06 

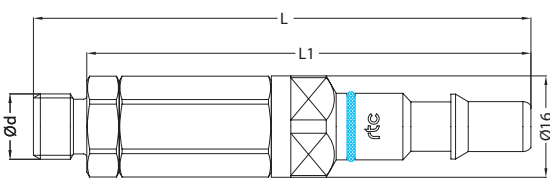
Plug / Nippel	Size / Größe	Alternative Order No Alternative Bestellnr.	Order No / Bestellnr.	Ød	L	L1	HEX.
 <p>*SS: Stainless Steel / Edelstahl (Colourless / Farblos) B: Blue / Blau (Coloured / Farbig)</p>	6	R353 00 248	452.06 PMB 413 SS/B	BSP 1/4	90	79	17
	6	R353 00 249	452.06 PMB 417 SS/B	BSP 3/8	90	79	19
	6	R353 00 307	452.06 PTB 413 SS/B	NPT 1/4	91	79	17
	6	R353 00 308	452.06 PTB 417 SS/B	NPT 3/8	91	79	19
	6	R353 00 358	452.06 PMB 413 SS	BSP 1/4	90	79	17
	6	R353 00 366	452.06 PMB 417 SS	BSP 3/8	90	79	19
	6	R353 00 386	452.06 PTB 413 SS	NPT 1/4	91	79	17
	6	R353 00 394	452.06 PTB 417 SS	NPT 3/8	91	79	19



Square coded female thread plug with valve / Viereck kodierter Verschlussnippel mit Innengewinde

TYPE 452.06 

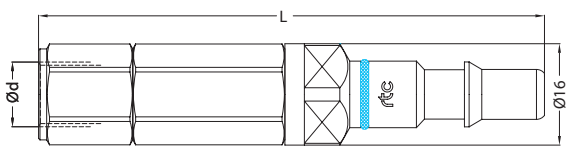
Plug / Nippel	Size / Größe	Alternative Order No Alternative Bestellnr.	Order No / Bestellnr.	Ød	L	L1	HEX.
 <p>*SS: Stainless Steel / Edelstahl (Colourless / Farblos) B: Blue / Blau (Coloured / Farbig)</p>	6	R353 00 246	452.06 PFB 413 SS/B	BSP 1/4	90	-	17
	6	R353 00 247	452.06 PFB 417 SS/B	BSP 3/8	90	-	19
	6	R353 00 305	452.06 PNB 413 SS/B	NPT 1/4	90	-	17
	6	R353 00 36	452.06 PNB 417 SS/B	NPT 3/8	90	-	19
	6	R353 00 362	452.06 PFB 413 SS	BSP 1/4	90	-	17
	6	R353 00 370	452.06 PFB 417 SS	BSP 3/8	90	-	19
	6	R353 00 390	452.06 PNB 413 SS	NPT 1/4	90	-	17
	6	R353 00 398	452.06 PNB 417 SS	NPT 3/8	90	-	19



Square coded standard hose plug with valve / Viereck kodierter Verschlussnippel mit Schlauchanschluss

TYPE 452.06 

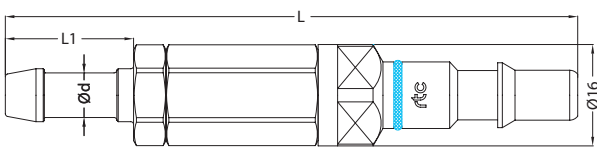
Plug / Nippel	Size / Größe	Alternative Order No Alternative Bestellnr.	Order No / Bestellnr.	Ød	Ød1	L	L1
 <p>*SS: Stainless Steel / Edelstahl (Colourless / Farblos) B: Blue / Blau (Coloured / Farbig)</p>	6	R353 00 250	452.06 PHB 406 SS/B	Ø6 - 1/4	-	100	23
	6	R353 00 251	452.06 PHB 408 SS/B	Ø8 - 5/16	-	100	23
	6	R353 00 252	452.06 PHB 410 SS/B	Ø10 - 3/8	-	100	23
	6	R353 00 378	452.06 PHB 406 SS	Ø6 - 1/4	-	100	23
	6	R353 00 382	452.06 PHB 408 SS	Ø8 - 5/16	-	100	23
	6	R353 00 374	452.06 PHB 410 SS	Ø10 - 3/8	-	100	23

rtc TYPE 452.06

Pentagonal coded male thread socket / Fünfeck kodierte Kupplung mit Aussengewinde



Socket / Kupplung

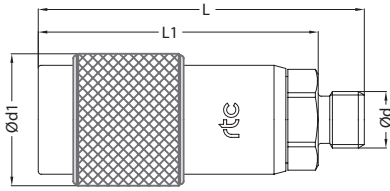

*SS: Stainless Steel / Edelstahl (Colourless / Farblos)
F: Grey / Grau (Coloured / Farbig)

Size / Größe	Alternative Order No Alternative Bestellnr.	Order No / Bestellnr.	Ød	Ød1	L	L1	HEX.
6	R303 00 399	452.06 SMB 513 SS/F	BSP 1/4	28	61.5	52	22
6	R303 00 400	452.06 SMB 517 SS/F	BSP 3/8	28	61.5	52	22
6	R303 00 657	452.06 SMB 521 SS/F	BSP 1/2	28	67.5	52	22
6	R303 00 492	452.06 STB 513 SS/F	NPT 1/4	28	62.5	52	22
6	R303 00 658	452.06 STB 517 SS/F	NPT 3/8	28	62.5	52	22
6	R303 00 750	452.06 SMB 513 SS	BSP 1/4	28	61.5	52	22
6	R303 00 751	452.06 SMB 517 SS	BSP 3/8	28	61.5	52	22
6	R303 00 752	452.06 SMB 521 SS	BSP 1/2	28	67.5	52	22
6	R303 00 753	452.06 STB 513 SS	NPT 1/4	28	62.5	52	22
6	R303 00 754	452.06 STB 517 SS	NPT 3/8	28	62.5	52	22
6	R203 00 395	452.06 SMB 513	BSP 1/4	28	61.5	52	22
6	R203 00 396	452.06 SMB 517	BSP 3/8	28	61.5	52	22
6	-	452.06 STB 513	NPT 1/4	28	62.5	52	22
6	-	452.06 STB 517	NPT 3/8	28	62.5	52	22

rtc TYPE 452.06

Pentagonal coded female thread socket / Fünfeck kodierte Kupplung mit Innengewinde



Socket / Kupplung

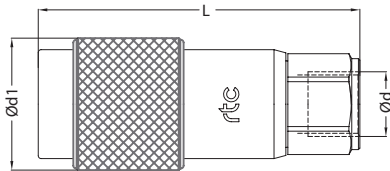

*SS: Stainless Steel / Edelstahl (Colourless / Farblos)
F: Grey / Grau (Coloured / Farbig)

Size / Größe	Alternative Order No Alternative Bestellnr.	Order No / Bestellnr.	Ød	Ød1	L	L1	HEX.
6	R303 00 655	452.06 SFB 510 SS/F	BSP 1/8	28	56	-	22
6	R303 00 396	452.06 SFB 513 SS/F	BSP 1/4	28	56	-	22
6	R303 00 397	452.06 SFB 517 SS/F	BSP 3/8	28	64.5	-	22
6	R303 00 398	452.06 SFB 521 SS/F	BSP 1/2	28	66.5	-	24
6	R303 00 491	452.06 SNB 513 SS/F	NPT 1/4	28	56	-	22
6	R303 00 656	452.06 SNB 517 SS/F	NPT 3/8	28	64.5	-	22
6	R303 00 744	452.06 SFB 510 SS	BSP 1/8	28	56	-	22
6	R303 00 745	452.06 SFB 513 SS	BSP 1/4	28	56	-	22
6	R303 00 746	452.06 SFB 517 SS	BSP 3/8	28	64.5	-	22
6	R303 00 747	452.06 SFB 521 SS	BSP 1/2	28	66.5	-	24
6	R303 00 748	452.06 SNB 513 SS	NPT 1/4	28	56	-	22
6	R303 00 749	452.06 SNB 517 SS	NPT 3/8	28	64.5	-	22
6	R203 00 392	451.06 SFB 513	BSP 1/4	28	56	-	22
6	R203 00 393	451.06 SFB 157	BSP 3/8	28	64.5	-	22
6	R203 00 394	451.06 SFB 521	BSP 1/2	28	66.5	-	24
6	-	451.06 SNB 513	NPT 1/4	28	56	-	22
6	-	451.06 SNB 517	NPT 3/8	28	64.5	-	22

rtc TYPE 452.06

Pentagonal coded standard hose socket / Fünfeck kodierte Kupplung mit Schlauchanschluss



Socket / Kupplung

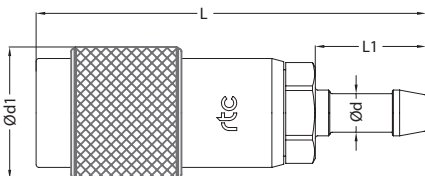

*SS: Stainless Steel / Edelstahl (Colourless / Farblos)
F: Grey / Grau (Coloured / Farbig)

Size / Größe	Alternative Order No Alternative Bestellnr.	Order No / Bestellnr.	Ød	Ød1	L	L1	HEX.
6	R303 00 401	452.06 SHB 506 SS/F	Ø6 - 1/4	28	74.5	23	-
6	R303 00 402	452.06 SHB 508 SS/F	Ø8 - 5/16	28	74.5	23	-
6	R303 00 403	452.06 SHB 510 SS/F	Ø10 - 3/8	28	74.5	23	-
6	R303 00 659	452.06 SHB 513 SS/F	Ø13 - 1/2	28	74.5	23	-
6	R303 00 755	452.06 SHB 506 SS	Ø6 - 1/4	28	74.5	23	-
6	R303 00 756	452.06 SHB 508 SS	Ø8 - 5/16	28	74.5	23	-
6	R303 00 757	452.06 SHB 510 SS	Ø10 - 3/8	28	74.5	23	-
6	R303 00 758	452.06 SHB 513 SS	Ø13 - 1/2	28	74.5	23	-
6	R203 00 397	452.06 SHB 506	Ø6 - 1/4	28	74.5	23	-
6	R203 00 398	452.06 SHB 508	Ø8 - 5/16	28	74.5	23	-
6	R203 00 399	452.06 SHB 510	Ø10 - 3/8	28	74.5	23	-
6	-	452.06 SHB 513	Ø13 - 1/2	28	74.5	23	-

Pentagonal coded male thread plug / Fünfeck kodierter Nippel mit Aussengewinde

TYPE 452.06 

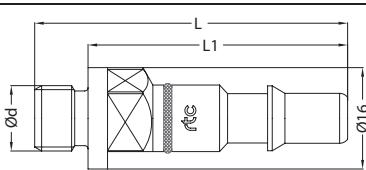
Plug / Nippel	Size / Größe	Alternative Order No Alternative Bestellnr.	Order No / Bestellnr.	Ød	Ød1	L	L1	HEX.
 <p>*SS: Stainless Steel / Edelstahl (Colourless / Farblos) F: Grey / Grau (Coloured / Farbig)</p>	6	R390 00 310	452.06 PMB 510 SS	BSP 1/8	-	44	36	17
	6	R390 00 311	452.06 PMB 513 SS	BSP 1/4	-	47	36	17
	6	R390 00 366	452.06 PTB 513 SS	NPT 1/4	-	47	36	17
	6	R355 00 306	452.06 PMB 510 SS/F	BSP 1/8	-	44	36	17
	6	R355 00 307	452.06 PMB 513 SS/F	BSP 1/4	-	47	36	17
	6	R355 00 345	452.06 PTB 513 SS/F	NPT 1/4	-	47	36	17

Pentagonal standard hose plug / Fünfeck kodierter Nippel mit Schlauchanschluss

TYPE 452.06 

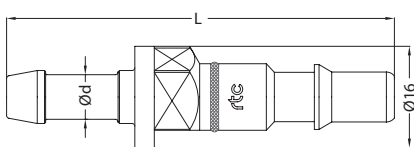
Plug / Nippel	Size / Größe	Alternative Order No Alternative Bestellnr.	Order No / Bestellnr.	Ød	Ød1	L	L1	HEX.
 <p>*SS: Stainless Steel / Edelstahl (Colourless / Farblos) F: Grey / Grau (Coloured / Farbig)</p>	6	R390 00 312	452.06 PHF 506 SS	Ø6 - 1/4	-	55.5	23	-
	6	R390 00 313	452.06 PHF 508 SS	Ø8 - 5/16	-	55.5	23	-
	6	R390 00 314	452.06 PHF 510 SS	Ø10 - 3/8	-	55.5	23	-
	6	R355 00 308	452.06 PHF 506 SS/F	Ø6 - 1/4	-	55.5	23	-
	6	R355 00 309	452.06 PHF 508 SS/F	Ø8 - 5/16	-	55.5	23	-
	6	R355 00 310	452.06 PHF 510 SS/F	Ø10 - 3/8	-	55.5	23	-

Pentagonal male thread plug with valve / Fünfeck kodierter Verschlussnippel mit Aussengewinde

TYPE 452.06 

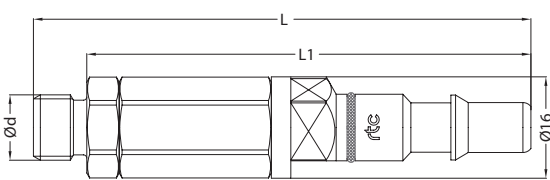
Plug / Nippel	Size / Größe	Alternative Order No Alternative Bestellnr.	Order No / Bestellnr.	Ød	L	L1	HEX.
 <p>*SS: Stainless Steel / Edelstahl (Colourless / Farblos) F: Grey / Grau (Coloured / Farbig)</p>	6	R353 00 357	452.06 PMB 513 SS	BSP 1/4	90	79	17
	6	R353 00 365	452.06 PMB 517 SS	BSP 3/8	90	79	19
	6	R353 00 385	452.06 PTB 513 SS	NPT 1/4	91	79	17
	6	R353 00 393	452.06 PTB 517 SS	NPT 3/8	91	79	19
	6	R353 00 362	452.06 PMB 513 SS/F	BSP 1/4	90	79	17
	6	R353 00 363	452.06 PMB 517 SS/F	BSP 3/8	90	79	19
	6	R353 00 303	452.06 PTB 513 SS/F	NPT 1/4	91	79	17
	6	R353 00 304	452.06 PTB 517 SS/F	NPT 3/8	91	79	19

Pentagonal coded female thread plug with valve / Fünfeck kodierter Verschlussnippel mit Innengewinde

TYPE 452.06 

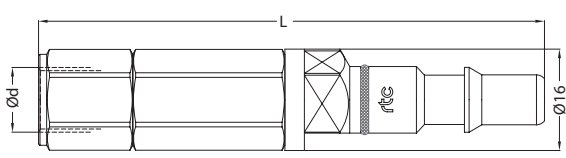
Plug / Nippel	Size / Größe	Alternative Order No Alternative Bestellnr.	Order No / Bestellnr.	Ød	L	L1	HEX.
 <p>*SS: Stainless Steel / Edelstahl (Colourless / Farblos) F: Grey / Grau (Coloured / Farbig)</p>	6	R353 00 361	452.06 PFB 513 SS	BSP 1/4	90	-	17
	6	R353 00 369	452.06 PFB 517 SS	BSP 3/8	90	-	19
	6	R353 00 389	452.06 PNB 513 SS	NPT 1/4	90	-	17
	6	R353 00 397	452.06 PNB 517 SS	NPT 3/8	90	-	19
	6	R353 00 260	452.06 PFB 513 SS/F	BSP 1/4	90	-	17
	6	R353 00 261	452.06 PFB 517 SS/F	BSP 3/8	90	-	19
	6	R353 00 301	452.06 PNB 513 SS/F	NPT 1/4	90	-	17
	6	R353 00 302	452.06 PNB 517 SS/F	NPT 3/8	90	-	19

Pentagonal coded standard hose plug with valve / Fünfeck kodierter Verschlussnippel mit Schlauchanschluss

TYPE 452.06 

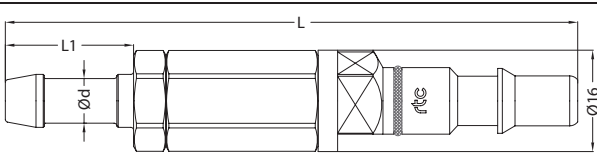
Plug / Nippel	Size / Größe	Alternative Order No Alternative Bestellnr.	Order No / Bestellnr.	Ød	Ød1	L	L1
 <p>*SS: Stainless Steel / Edelstahl (Colourless / Farblos) F: Grey / Grau (Coloured / Farbig)</p>	6	R353 00 377	452.06 PHB 506 SS	Ø6 - 1/4	-	100	13
	6	R353 00 381	452.06 PHB 508 SS	Ø8 - 5/16	-	100	13
	6	R353 00 373	452.06 PHB 510 SS	Ø10 - 3/8	-	100	13
	6	R353 00 264	452.06 PHB 506 SS/F	Ø6 - 1/4	-	100	13
	6	R353 00 265	452.06 PHB 508 SS/F	Ø8 - 5/16	-	100	13
	6	R353 00 266	452.06 PHB 510 SS/F	Ø10 - 3/8	-	100	13



rtc[®]

QUICK CONNECT TECHNOLOGY
www.rtc-tec.com

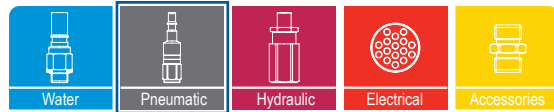

SC rtc TYPE



Temperature Range - Temperaturbereich

Nitrile (N)	-20°C + 110°C (-4°F +230°F)
FPM (V)	-20°C + 180°C (-4°F +356°F)
EPDM (Ethylene Propylene)	-40°C + 150°C (-40°F +302°F)

Working Pressure - Betriebsdruck

25 Bar (360 PSI)

Connction/Disconnection Max. Pressure - Ein und Auskuppelbar bis Max. Druck

15 Bar (220 PSI)

Advantages

- The system perfectly fits to the **ISO 4414 & EN 983** safety requirements.
- Through flow, minimum pressure loss.
- Negligible Connecting Force
- Smart and Ergonomic features
- Ease of Handling
- Optimised Size

Vorteil

- Sicherheit gemäß **ISO 4414 & EN 983**
- Voller Durchgang, sehr geringer Druckverlust
- Einfache Bedienung, sehr geringe Kuppelkraft
- Kompakte Bauform

Simple and quick connection with no force and pressure drop

Connection: Push suitable plug into coupling and swing approximately 90° until the orange sleeve engages in the groove.

Disconnection: Pull back orange sleeve and swing plug to stop. Remove plug from coupling.

In order to prevent the hose from ejecting dangerously, the plug must be held in the hand until the hose is completely ventilated.

Einfach und schnell verbinden mit sehr geringem Kraufaufwand und Druckverlust

Verbinden: Nippel in die Kupplung einstecken und 90° schwenken, bis die orangene Hülse in die Nut einrastet.

Trennen: Orangene Hülse zurückziehen und den Nippel 90° schwenken. Nippel aus der Kupplung entnehmen.

Um ein gefährliches Rückschlagen des Schlauches zu vermeiden, muss der Nippel so lange in der Hand gehalten werden, bis der Druckluftschlauch vollständig entlüftet ist.

Flow size - Nennweiten

rtc type 460.06 / SC-B1	5.5mm (1/4")
rtc type 460.08 / SC-E	8mm (3/8")
rtc type 460.11 / SC-H&HB	11mm (1/2")
rtc type 461.06 / SC-K	5.5mm (1/4")
rtc type 461.08 / SC-E1	8mm (3/8")
rtc type 461.11 / SC-G	11mm (1/2")
rtc type 461.19 / SC-I	19mm (3/4")
rtc type 462.06 / SC-A1	5.5mm (1/4")
rtc type 463.08 / SC-C	8mm (3/8")
rtc type 464.08 / SC-D&DL	8mm (3/8")
rtc type 465.08 / SC-M	8mm (3/8")
rtc type 466.06 / SC-P	5.5mm (1/4")
rtc type 467.06 / SC-N	5.5mm (1/4")
rtc type 468.08	8mm (3/8")

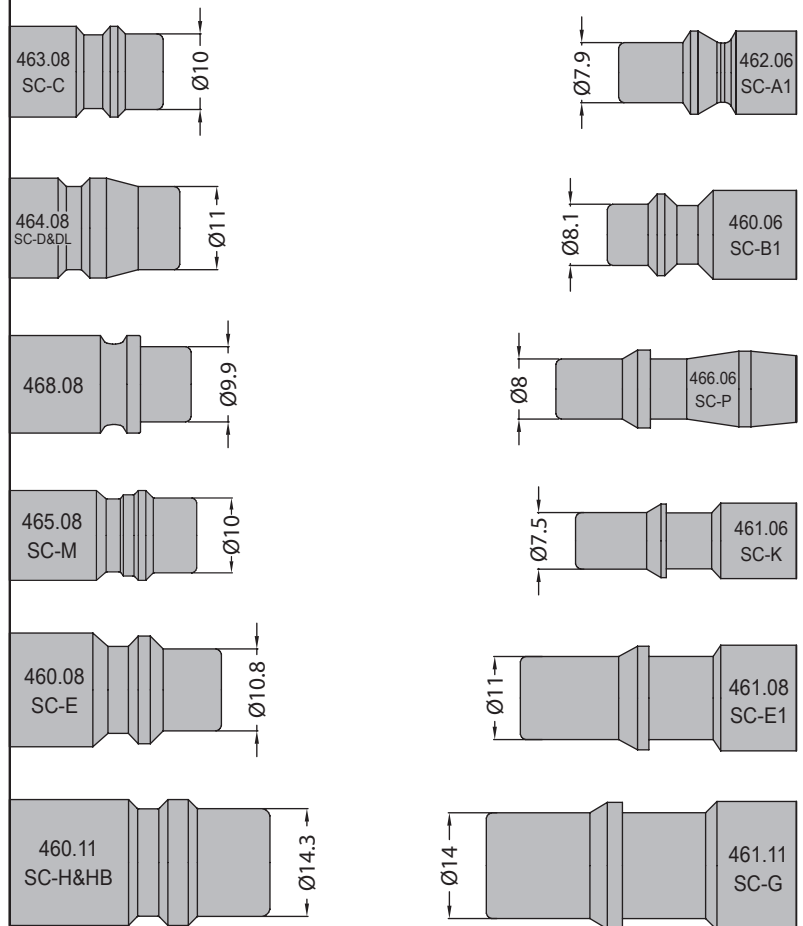

Flow Rate vs Pressure Drop Graph

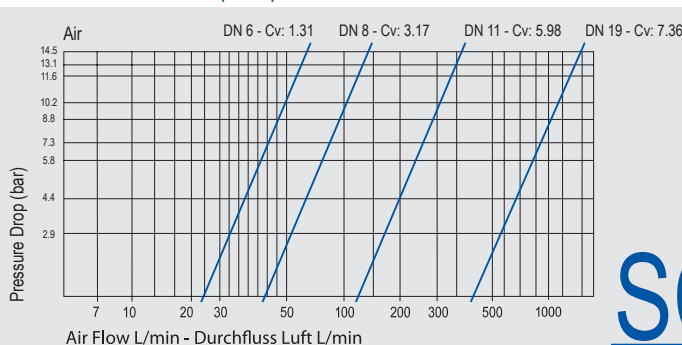

Plug form 1:1
Abbildung 1:1



rtc[®]

QUICK CONNECT TECHNOLOGY
www.rtc-tec.com

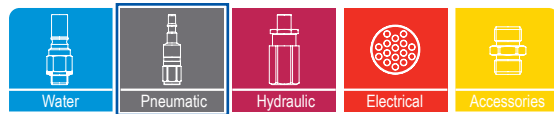

460.06

rtc TYPE





Compatible - Kompatibilität

Ind. Interchange	1/4
rtc	023
Cejn	310
Parker	B23
Rectus	23
Foster	3003
AMFLO	C208
Hansen	1000

Temperature Range - Temperaturbereich

Nitrile (N)	-20°C + 110°C (-4°F + 230°F)
FPM (V)	-20°C + 180°C (-4°F + 356°F)
EPDM (Ethylene Propylene)	-40°C + 150°C (-40°F + 302°F)

Working Pressure - Betriebsdruck

25 Bar (360 PSI)

Connction / Disconnection Max. Pressure -

Ein- und Auskuppelbar bis Max. Druck
15 Bar (220 PSI)

Flow size - Nennweite

rtc type 460.06 5.5mm (1/4")

Standard version - Standardversion

Seals - Dichtung : Nitrile (N)

Material of Standard Coupler / Material für die Standardversion

Body / Housing - Kupplungsgrundkörper/Gehäuse	Steel tenifer threated Stahl teneferiert
Inner Part / Cylinder -	Surface hardened steel Zinc-nickel plated Stahl gehärtet, Zink-Nickel beschichtet
Innenteil / Zylinder	
Back Part - Hinterteil	Steel zinc plated - Stahl verzinkt
Sleeve -	Zinc diecasted, nickel plated & orange plastic coated
Hülse	Zink-Druckguss, vernickelt und orange Gummi beschichtet
Springs - Federn	Stainless steel - Edelstahl
Seals - Dichtungen	Nitrile (N)
Plug -	Surface hardened steel, galvanized
Nippel	Stahl gehärtet, verzinkt

Advantages

- The system perfectly fits to the ISO 4414, EN 983 safety requirements.
- Plug profile perfectly fits to the ISO 6150-B-12, AFNOR B-12 NF E 49-053, US MIL C-4109
- Through flow, minimum pressure loss.
- Negligible Connecting Force
- Smart and Ergonomic features
- Ease of Handling
- Optimised Size

Vorteil

- Sicherheit gemäß ISO 4414, EN 983
- Stecknippel gemäß ISO 6150-B-12, AFNOR B-12 NF E 49-053, US MIL C-4109
- Voller Durchgang, sehr geringer Druckverlust
- Einfache Bedienung, sehr geringe Kuppelkraft
- Kompakte Bauform



Flow Rate vs Pressure Drop Graph

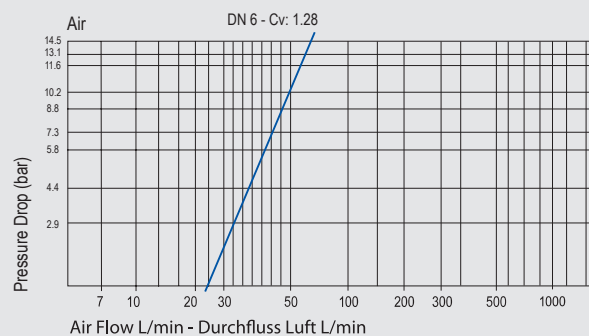

460.06
rtc TYPE

rtc TYPE 460.06

Male thread socket / Kupplung mit Aussengewinde



Socket / Kupplung

Size / Größe	Alternative Order No Alternative Bestellnr.	Order No / Bestellnr.	Ød	Ød1	L	L1	HEX.
6	R205 00 314	460.06 SMO 13	BSP 1/4	25	59.5	48.5	19
6	R205 00 315	460.06 SMO 17	BSP 3/8	25	59.5	48.5	19
6	R205 00 316	460.06 SMO 21	BSP 1/2	25	61.5	49.5	22
6	R205 00 317	460.06 STO 13	NPT 1/4	25	60.5	48.5	19
6	R205 00 318	460.06 STO 17	NPT 3/8	25	62.5	48.5	19
6	R205 00 319	460.06 STO 21	NPT 1/2	25	68.5	49.5	22

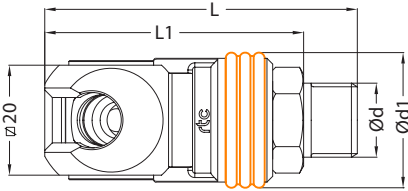

rtc TYPE 460.06

Female thread socket / Kupplung mit Innengewinde



Socket / Kupplung

Size / Größe	Alternative Order No Alternative Bestellnr.	Order No / Bestellnr.	Ød	Ød1	L	L1	HEX.
6	R205 00 307	460.06 SFO 13	BSP 1/4	25	56.5	-	19
6	R205 00 308	460.06 SFO 17	BSP 3/8	25	58.5	-	19
6	R205 00 309	460.06 SFO 21	BSP 1/2	25	60.5	-	24
6	R205 00 311	460.06 SNO 13	NPT 1/4	25	57.5	-	19
6	R205 00 312	460.06 SNO 17	NPT 3/8	25	59.5	-	20
6	R205 00 313	460.06 SNO 21	NPT 1/2	25	65.5	-	24

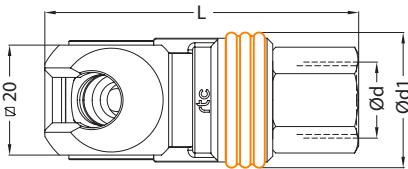

rtc TYPE 460.06

Socket with hose barb / Kupplung mit Schlauchanschluss



Socket / Kupplung

Size / Größe	Alternative Order No Alternative Bestellnr.	Order No / Bestellnr.	Ød	Ød1	L	L1	HEX.
6	R205 00 320	460.06 SHO 06	Ø6 - 1/4	25	69	-	-
6	R205 00 321	460.06 SHO 08	Ø8 - 5/16	25	69	-	-
6	R205 00 322	460.06 SHO 10	Ø10 - 3/8	25	69	-	-

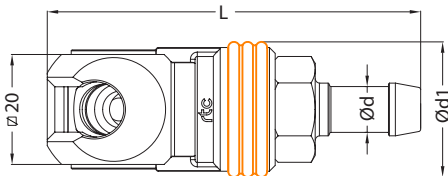

rtc TYPE 460.06

Socket with plastic hose connection / Kupplung mit Kunststoffschlauchanschluss



Socket / Kupplung

Size / Größe	Alternative Order No Alternative Bestellnr.	Order No / Bestellnr.	Ød	Ød1	L	L1	HEX.
6	R205 00 324	460.06 SVO 0610	6.5x10	25	70	-	22
6	R205 00 325	460.06 SVO 0812	8x12	25	70	-	22

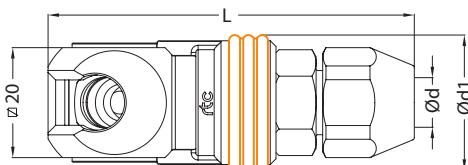

Plug with male thread / Nippel mit Aussengewinde TYPE 460.06 **rtc**

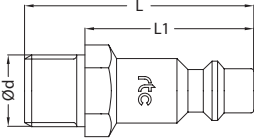
Plug / Nippel	Size / Größe	Alternative Order No Alternative Bestellnr.	Order No / Bestellnr.	Ød	Ød1	L	L1	HEX.
	6	R255 00 011	460.06 PMF 10	BSP 1/8	-	38	30	14
	6	R255 00 012	460.06 PMF 13	BSP 1/4	-	42	31	14
	6	-	460.06 PMF 17	BSP 3/8	-	43.5	32.5	19
	6	R255 00 013	460.06 PTF 10	NPT 1/8	-	41	32	14
	6	R255 00 014	460.06 PTF 13	NPT 1/4	-	44	32	14
	6	R255 00 069	460.06 PTF 17	NPT 3/8	-	47	35	19

Plug with female thread / Nippel mit Innengewinde TYPE 460.06 **rtc**

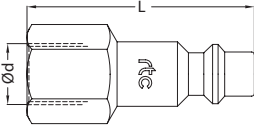
Plug / Nippel	Size / Größe	Alternative Order No Alternative Bestellnr.	Order No / Bestellnr.	Ød	Ød1	L	L1	HEX.
	6	R255 00 015	460.06 PFF 10	BSP 1/8	-	42	-	14
	6	R255 00 016	460.06 PFF 13	BSP 1/4	-	42.5	-	17
	6	-	460.06 PFF 17	BSP 3/8	-	43.5	-	19
	6	R255 00 017	460.06 PNF 10	NPT 1/8	-	39	-	14
	6	R255 00 018	460.06 PNF 13	NPT 1/4	-	43	-	17
	6	R255 00 274	460.06 PNF 17	NPT 3/8	-	44	-	19

Plug with hose barb / Nippel mit Schlauchanschluss TYPE 460.06 **rtc**

Plug / Nippel	Size / Größe	Alternative Order No Alternative Bestellnr.	Order No / Bestellnr.	Ød	Ød1	L	L1	HEX.
	6	R255 00 019	460.06 PHF 06	Ø6 - 1/4	14	51	-	-
	6	R255 00 020	460.06 PHF 08	Ø8 - 5/16	14	51	-	-
	6	R255 00 021	460.06 PHF 10	Ø10 - 3/8	14	51	-	-

Plug with plastic hose connection / Nippel mit Kunststoffschlauchanschluss TYPE 460.06 **rtc**

Plug / Nippel	Size / Größe	Alternative Order No Alternative Bestellnr.	Order No / Bestellnr.	Ød	Ød1	L	L1	HEX.
	6	-	460.06 PVF 0610	6.5x10	-	54	-	22
	6	R255 00 413	460.06 PVF 0812	8x12	-	54	-	22



rtc[®]

QUICK CONNECT TECHNOLOGY
www.rtc-tec.com



460.08

rtc TYPE



Compatible - Kompatibilität

Ind. Interchange	3/8
rtc	030
Cejn	430
Parker	25F
Rectus	30
Foster	4404
AMFLO	C26
Hansen	440

Temperature Range - Temperaturbereich

Nitrile (N)	-20°C + 110°C (- 4°F + 230°F)
FPM (V)	-20°C + 180°C (- 4°F + 356°F)
EPDM (Ethylene Propylene)	-40°C + 150°C (- 40°F + 302°F)

Working Pressure - Betriebsdruck

25 Bar (360 PSI)

Connction / Disconnection Max. Pressure -

Ein- und Auskuppelbar bis Max. Druck
15 Bar (220 PSI)

Flow size - Nennweite

rtc type 460.08 8mm (3/8")

Standard version - Standardversion

Seals - Dichtung : Nitrile (N)

Material of Standard Coupler / Material für die Standardversion

Body / Housing -	Steel tenifer threated
Kupplungsgrundkörper/Gehäuse	Stahl teneferiert
Inner Part / Cylinder -	Surface hardened steel Zinc-nickel plated
Innenteil / Zylinder	Stahl gehärtet, Zink-Nickel beschichtet
Back Part - Hinterteil	Steel zinc plated - Stahl verzinkt
Sleeve -	Zinc diecasted, nickel plated & orange plastic coated
Hülse	Zink-Druckguss, vernickelt und orange Gummi beschichtet
Springs - Federn	Stainless steel - Edelstahl
Seals - Dichtungen	Nitrile (N)
Plug -	Surface hardened steel, galvanized
Nippel	Stahl gehärtet, verzinkt

Advantages

- The system perfectly fits to the **ISO 4414**, **EN 983** safety requirements.
- Plug profile perfectly fits to the **ISO 6150-B-15**, **AFNOR B-15 NF E 49-053**, **US MIL C-4109**
- Through flow, minimum pressure loss.
- Negligible Connecting Force
- Smart and Ergonomic features
- Ease of Handling
- Optimised Size

Vorteil

- Sicherheit gemäß **ISO 4414**, **EN 983**
- Stecknippel gemäß **ISO 6150-B-15**, **AFNOR B-15 NF E 49-053**, **US MIL C-4109**
- Voller Durchgang, sehr geringer Druckverlust
- Einfache Bedienung, sehr geringe Kuppelkraft
- Kompakte Bauform



Flow Rate vs Pressure Drop Graph

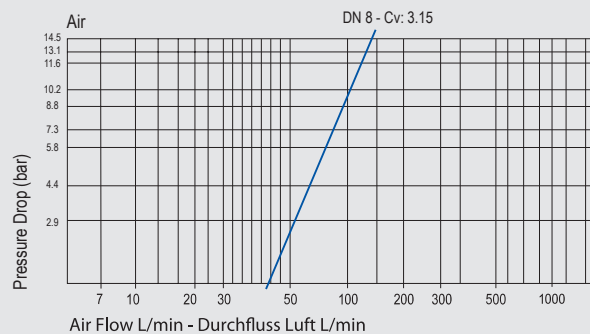

460.08
rtc TYPE

rtc TYPE 460.08

Male thread socket / Kupplung mit Aussengewinde



Socket / Kupplung

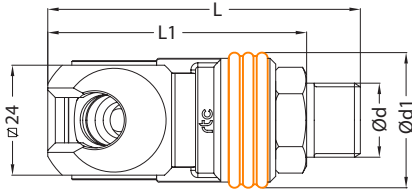

Size / Größe	Alternative Order No Alternative Bestellnr.	Order No / Bestellnr.	Ød	Ød1	L	L1	HEX.
8	R205 00 028	460.08 SMO 13	BSP 1/4	30	68.5	57.5	20
8	R205 00 029	460.08 SMO 17	BSP 3/8	30	68.5	57.5	20
8	R205 00 045	460.08 SMO 21	BSP 1/2	30	70.5	58.5	22
8	R205 00 214	460.08 STO 13	NPT 1/4	30	69.5	57.5	20
8	R205 00 030	460.08 STO 17	NPT 3/8	30	70.5	56.5	20
8	R205 00 031	460.08 STO 21	NPT 1/2	30	77.5	58.5	22
8	R205 00 039	460.08 SRO 13	BSPT 1/4	30	69.5	57.5	20
8	R205 00 040	460.08 SRO 17	BSPT 3/8	30	70.5	56.5	20
8	R205 00 041	460.08 SRO 21	BSPT 1/2	30	77.5	58.5	22

rtc TYPE 460.08

Female thread socket / Kupplung mit Innengewinde



Socket / Kupplung

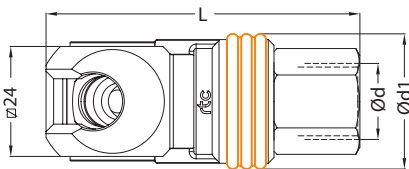

Size / Größe	Alternative Order No Alternative Bestellnr.	Order No / Bestellnr.	Ød	Ød1	L	L1	HEX.
8	R205 00 023	460.08 SFO 13	BSP 1/4	30	68.5	-	20
8	R205 00 024	460.08 SFO 17	BSP 3/8	30	68.5	-	20
8	R205 00 025	460.08 SFO 21	BSP 1/2	30	69.5	-	24
8	R205 00 052	460.08 SNO 13	NPT 1/4	30	68.5	-	20
8	R205 00 026	460.08 SNO 17	NPT 3/8	30	68.5	-	20
8	R205 00 027	460.08 SNO 21	NPT 1/2	30	69.5	-	24
8	R205 00 046	460.08 SQO 13	BSPT 1/4	30	68.5	-	20
8	R205 00 047	460.08 SQO 17	BSPT 3/8	30	68.5	-	20
8	R205 00 048	460.08 SQO 21	BSPT 1/2	30	69.5	-	24

rtc TYPE 460.08

Socket with hose barb / Kupplung mit Schlauchanschluss



Socket / Kupplung

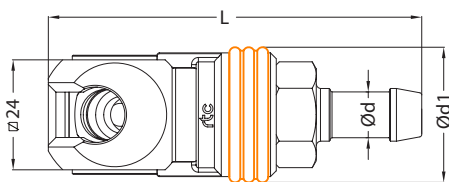

Size / Größe	Alternative Order No Alternative Bestellnr.	Order No / Bestellnr.	Ød	Ød1	L	L1	HEX.
8	R205 00 083	460.08 SHO 08	Ø8 - 5/16	30	82	-	-
8	R205 00 084	460.08 SHO 10	Ø10 - 3/8	30	82	-	-
8	R205 00 085	460.08 SHO 13	Ø13 - 1/2	30	82	-	-

rtc TYPE 460.08

Socket with plastic hose connection / Kupplung mit Kunststoffschlauchanschluss



Socket / Kupplung

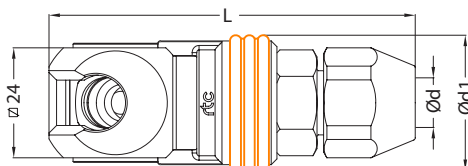

Size / Größe	Alternative Order No Alternative Bestellnr.	Order No / Bestellnr.	Ød	Ød1	L	L1	HEX.
8	R205 00 086	460.08 SVO 0610	6.5x10	30	69	-	22
8	R205 00 087	460.08 SVO 0812	8x12	30	69	-	22
8	R205 00 088	460.08 SVO 1116	11x16	30	75	-	27

Plug with male thread / Nippel mit Aussengewinde TYPE 460.08 **rtc**

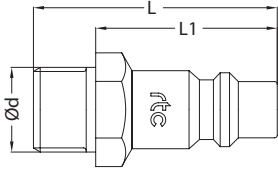
Plug / Nippel	Size / Größe	Alternative Order No Alternative Bestellnr.	Order No / Bestellnr.	Ød	Ød1	L	L1	HEX.
	8	R255 00 041	460.08 PMF 13	BSP 1/4	-	46	35	17
	8	R255 00 042	460.08 PMF 17	BSP 3/8	-	46	35	19
	8	-	460.08 PMF 21	BSP 1/2	-	53	38	22
	8	R255 00 236	460.08 PTF 13	NPT 1/4	-	47	35	17
	8	R255 00 044	460.08 PTF 17	NPT 3/8	-	47	35	19
	8	R255 00 045	460.08 PTF 21	NPT 1/2	-	55	38	22

Plug with female thread / Nippel mit Innengewinde TYPE 460.08 **rtc**

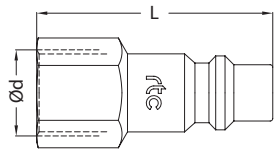
Plug / Nippel	Size / Größe	Alternative Order No Alternative Bestellnr.	Order No / Bestellnr.	Ød	Ød1	L	L1	HEX.
	8	R255 00 046	460.08 PFF 13	BSP 1/4	-	42	-	17
	8	R255 00 047	460.08 PFF 17	BSP 3/8	-	46.5	-	19
	8	R255 00 048	460.08 PFF 21	BSP 1/2	-	50	-	24
	8	R255 00 237	460.08 PNF 13	NPT 1/4	-	42	-	17
	8	R255 00 049	460.08 PNF 17	NPT 3/8	-	46.5	-	22
	8	R255 00 050	460.08 PNF 21	NPT 1/2	-	51	-	27

Plug with hose barb / Nippel mit Schlauchanschluss TYPE 460.08 **rtc**

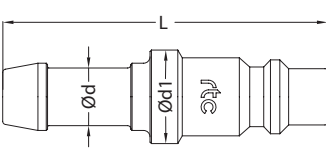
Plug / Nippel	Size / Größe	Alternative Order No Alternative Bestellnr.	Order No / Bestellnr.	Ød	Ød1	L	L1	HEX.
	8	R255 00 051	460.08 PHF 08	Ø8 - 5/16	16	54	-	-
	8	R255 00 052	460.08 PHF 10	Ø10 - 3/8	16	54	-	-
	8	R255 00 053	460.08 PHF 13	Ø13 - 1/2	16	54	-	-
	8	R255 00 054	460.08 PHF 16	Ø16 - 5/8	18	54	-	-

Plug with plastic hose connection / Nippel mit Kunststoffschlauchanschluss TYPE 460.08 **rtc**

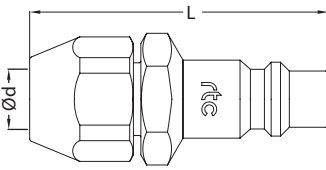
Plug / Nippel	Size / Größe	Alternative Order No Alternative Bestellnr.	Order No / Bestellnr.	Ød	Ød1	L	L1	HEX.
	8	-	460.08 PVF 0610	6.5x10		57		22
	8	R255 00 415	460.08 PVF 0812	8x12		57		22
	8	-	460.08 PVF 1116	11x16		65		27



rtc[®]

QUICK CONNECT TECHNOLOGY
www.rtc-tec.com

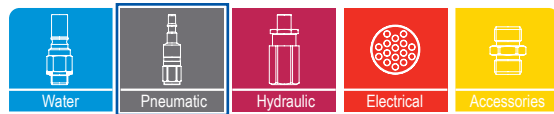

460.11

rtc TYPE



Compatible - Kompatibilität

Ind. Interchange	1/2
rtc	037
Cejn	550
Parker	17
Rectus	37
Foster	5205
AMFLO	C10
Hansen	520

Temperature Range - Temperaturbereich

Nitrile (N)	-20°C + 110°C (-4°F + 230°F)
FPM (V)	-20°C + 180°C (-4°F + 356°F)
EPDM (Ethylene Propylene)	-40°C + 150°C (-40°F + 302°F)

Working Pressure - Betriebsdruck

25 Bar (360 PSI)

Connction / Disconnection Max. Pressure -

Ein- und Auskuppelbar bis Max. Druck
15 Bar (220 PSI)

Flow size - Nennweite

rtc type 460.11 11mm (1/2")

Standard version - Standardversion

Seals - Dichtung : Nitrile (N)

Material of Standard Coupler (steel)

Material für die Standardversion (Stahl)

Body / Housing - Kupplungsgrundkörper/Gehäuse	Steel tenifer threaded Stahl Ttneferiert
Inner Part / Cylinder - Innenteil / Zylinder	Surface hardened steel Zinc-nickel plated Stahl gehärtet, Zink-Nickel beschichtet
Back Part - Hinterteil	Steel zinc plated - Stahl verzinkt
Sleeve - Hülse	Steel zinc nickel plated & orange painted Stahl Zink-Nickel beschichtet und orange lackiert
Springs - Federn	Stainless steel - Edelstahl
Seals - Dichtungen	Nitrile (N)
Plug - Nippel	Surface hardened steel, galvanized Stahl gehärtet, verzinkt

Advantages

- The system perfectly fits to the **ISO 4414, EN 983** safety requirements.
- Plug profile perfectly fits to the **ISO 6150-C-17, AFNOR C-17 NF E 49-053, US MIL C-4109**
- Through flow, minimum pressure loss.
- Negligible Connecting Force
- Smart and Ergonomic features
- Ease of Handling
- Optimised Size

Vorteil

- Sicherheit gemäß **ISO 4414, EN 983**
- Stecknippel gemäß **ISO 6150-C-17, AFNOR C-17 NF E 49-053, US MIL C-4109**
- Voller Durchgang, sehr geringer Druckverlust
- Einfache Bedienung, sehr geringe Kuppelkraft
- Kompakte Bauform

Brass Version (MS)

- Corrosion and ozone proof
- Suitable for internal and external applications

Messing Version (MS)

- Korrosion- und ozonbeständig
- Geeignet für Innen- und Aussenanwendungen

Material of Coupler (brass)

Material für die Kupplung (Messing)

Body / Housing - Kupplungsgrundkörper/Gehäuse	Brass nickel plated - Messing vernickelt
Inner Part / Cylinder - Innenteil / Zylinder	Aluminium
Back Part - Hinterteil	Aluminum
Sleeve - Hülse	Brass nickel plated - Messing vernickelt
Springs - Federn	Brass nickel plated - Messing vernickelt
Seals - Dichtungen	Stainless steel - Edelstahl
Plug - Nippel	FPM (V)
	Stainless steel - Edelstahl



Flow Rate vs Pressure Drop Graph

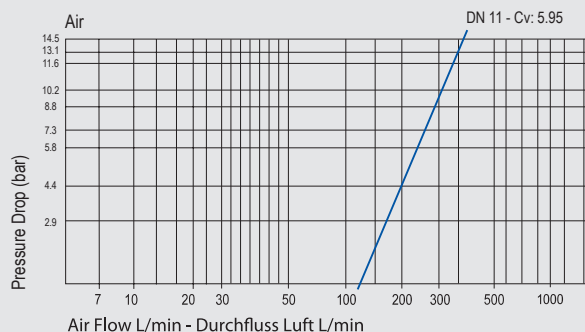

460.11
rtc TYPE

rtc TYPE 460.11

Male thread socket / Kupplung mit Aussengewinde



Socket / Kupplung

Size / Größe	Alternative Order No Alternative Bestellnr.	Order No / Bestellnr.	Ød	Ød1	L	L1	HEX.
11	R205 00 106	460.11 SMO 17	BSP 3/8	38	81.5	70.5	30
11	R205 00 107	460.11 SMO 21	BSP 1/2	38	82.5	70.5	30
11	R205 00 108	460.11 SMO 26	BSP 3/4	38	85.5	70.5	30
11	R205 00 112	460.11 STO 17	NPT 3/8	38	85.5	70.5	30
11	R205 00 113	460.11 STO 21	NPT 1/2	38	88.5	70.5	30
11	R205 00 114	460.11 STO 26	NPT 3/4	38	89.5	70.5	30
11	-	460.11 SMO 17 MS	BSP 3/8	38	81.5	70.5	30
11	R205 00 743	460.11 SMO 21 MS	BSP 1/2	38	82.5	70.5	30
11	R205 00 744	460.11 SMO 26 MS	BSP 3/4	38	85.5	70.5	30
11	-	460.11 STO 17 MS	NPT 3/8	38	85.5	70.5	30
11	R205 00 745	460.11 STO 21 MS	NPT 1/2	38	88.5	70.5	30
11	R205 00 746	460.11 STO 26 MS	NPT 3/4	38	89.5	70.5	30

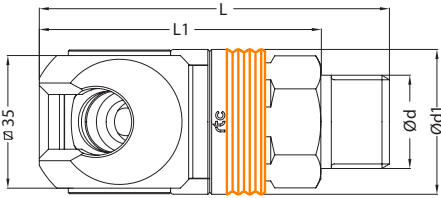

*MS: Brass / Messing

rtc TYPE 460.11

Female thread socket / Kupplung mit Innengewinde



Socket / Kupplung

Size / Größe	Alternative Order No Alternative Bestellnr.	Order No / Bestellnr.	Ød	Ød1	L	L1	HEX.
11	R205 00 103	460.11 SFO 17	BSP 3/8	38	79	-	30
11	R205 00 104	460.11 SFO 21	BSP 1/2	38	80.5	-	30
11	R205 00 105	460.11 SFO 26	BSP 3/4	38	83.5	-	32
11	R205 00 109	460.11 SNO 17	NPT 3/8	38	79	-	30
11	R205 00 110	460.11 SNO 21	NPT 1/2	38	80.5	-	30
11	R205 00 111	460.11 SNO 26	NPT 3/4	38	83.5	-	32
11	-	460.11 SFO 17 MS	BSP 3/8	38	79	-	30
11	R205 00 685	460.11 SFO 21 MS	BSP 1/2	38	80.5	-	30
11	R205 00 684	460.11 SFO 26 MS	BSP 3/4	38	83.5	-	32
11	-	460.11 SNO 17 MS	NPT 3/8	38	79	-	30
11	R205 00 687	460.11 SNO 21 MS	NPT 1/2	38	80.5	-	30
11	R205 00 686	460.11 SNO 26 MS	NPT 3/4	38	83.5	-	32

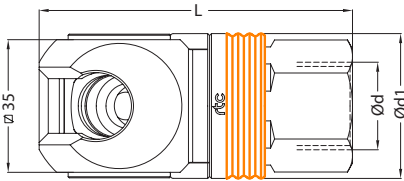

*MS: Brass / Messing

rtc TYPE 460.11

Socket with hose barb / Kupplung mit Schlauchanschluss



Socket / Kupplung

Size / Größe	Alternative Order No Alternative Bestellnr.	Order No / Bestellnr.	Ød	Ød1	L	L1	HEX.
11	-	460.11 SHO 10	Ø10 - 3/8	38	96.5	-	-
11	R205 00 712	460.11 SHO 13	Ø13 - 1/2	38	96.5	-	-
11	-	460.11 SHO 16	Ø16 - 5/8	38	96.5	-	-
11	-	460.11 SHO 10 MS	Ø10 - 3/8	38	96.5	-	-
11	-	460.11 SHO 13 MS	Ø13 - 1/2	38	96.5	-	-
11	-	460.11 SHO 16 MS	Ø16 - 5/8	38	96.5	-	-

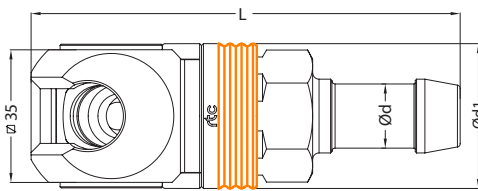

*MS: Brass / Messing

rtc TYPE 460.11

Socket with plastic hose connection / Kupplung mit Kunststoffschlauchanschluss



Socket / Kupplung

Size / Größe	Alternative Order No Alternative Bestellnr.	Order No / Bestellnr.	Ød	Ød1	L	L1	HEX.
11	-	460.11 SVO 0812	8x12	38	93	-	22
11	-	460.11 SVO 1116	11x16	38	93	-	27
11	-	460.11 SVO 0812 MS	8x12	38	93	-	22
11	-	460.11 SVO 1116 MS	11x16	38	93	-	27

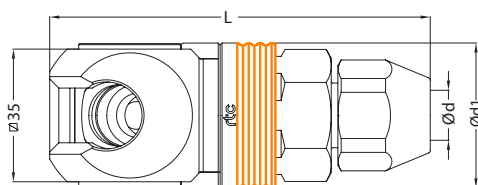

*MS: Brass / Messing

Plug with male thread / Nippel mit Aussengewinde TYPE 460.11 

Plug / Nippel	Size / Größe	Alternative Order No Alternative Bestellnr.	Order No / Bestellnr.	Ød	Ød1	L	L1	HEX.
	11	R255 00 074	460.11 PMF 17	BSP 3/8	-	56	45	19
	11	R255 00 075	460.11 PMF 21	BSP 1/2	-	59	45	24
	11	R255 00 290	460.11 PMF 26	BSP 3/4	-	60	45	27
	11	R255 00 277	460.11 PTF 17	NPT 3/8	-	57	45	19
	11	R255 00 278	460.11 PTF 21	NPT 1/2	-	62	45	24
	11	R255 00 291	460.11 PTF 26	NPT 3/4	-	64	45	27
	11	R355 00 250	460.11 PMF 17 SS	BSP 3/8	-	56	45	19
	11	R355 00 075	460.11 PMF 21 SS	BSP 1/2	-	59	45	24
	11	R355 00 327	460.11 PMF 26 SS	BSP 3/4	-	60	45	27
	11	-	460.11 PTF 17 SS	NPT 3/8	-	57	45	19
	11	R355 00 328	460.11 PTF 21 SS	NPT 1/2	-	62	45	24
	11	R355 00 253	460.11 PTF 26 SS	NPT 3/4	-	64	45	27

Plug with female thread / Nippel mit Innengewinde TYPE 460.11 

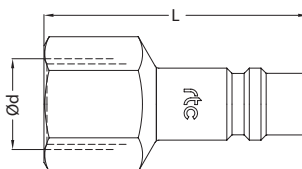
Plug / Nippel	Size / Größe	Alternative Order No Alternative Bestellnr.	Order No / Bestellnr.	Ød	Ød1	L	L1	HEX.
	11	R255 00 076	460.11 PFF 17	BSP 3/8	-	59	-	19
	11	R255 00 077	460.11 PFF 21	BSP 1/2	-	61	-	27
	11	R255 00 078	460.11 PFF 26	BSP 3/4	-	63	-	32
	11	R255 00 279	460.11 PNF 17	NPT 3/8	-	59	-	19
	11	R255 00 280	460.11 PNF 21	NPT 1/2	-	61	-	27
	11	R255 00 292	460.11 PNF 26	NPT 3/4	-	63	-	32
	11	R355 00 076	460.11 PFF 17 SS	BSP 3/8	-	59	-	19
	11	R355 00 077	460.11 PFF 21 SS	BSP 1/2	-	61	-	27
	11	R355 00 078	460.11 PFF 26 SS	BSP 3/4	-	63	-	32
	11	-	460.11 PNF 17 SS	NPT 3/8	-	59	-	19
	11	R355 00 255	460.11 PNF 21 SS	NPT 1/2	-	61	-	27
	11	R355 00 256	460.11 PNF 26 SS	NPT 3/4	-	63	-	32

Plug with hose barb / Nippel mit Schlauchanschluss TYPE 460.11 

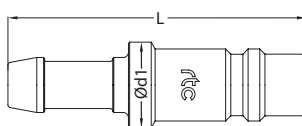
Plug / Nippel	Size / Größe	Alternative Order No Alternative Bestellnr.	Order No / Bestellnr.	Ød	Ød1	L	L1	HEX.
	11	R255 00 079	460.11 PHF 10	Ø10 - 3/8	18	62	-	-
	11	R255 00 080	460.11 PHF 13	Ø13 - 1/2	20	68	-	-
	11	R255 00 081	460.11 PHF 16	Ø16 - 5/8	22	79	-	-
	11	R355 00 079	460.11 PHF 10 SS	Ø10 - 3/8	18	62	-	-
	11	R355 00 080	460.11 PHF 13 SS	Ø13 - 1/2	20	68	-	-
	11	R355 00 081	460.11 PHF 16 SS	Ø16 - 5/8	22	79	-	-

Plug with plastic hose connection / Nippel mit Kunststoffschlussschlauchanschluss TYPE 460.11 

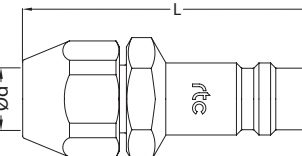
Plug / Nippel	Size / Größe	Alternative Order No Alternative Bestellnr.	Order No / Bestellnr.	Ød	Ød1	L	L1	HEX.
	11	-	460.11 PVF 0812	8x12	-	65	-	22
	11	-	460.11 PVF 1116	11x16	-	70	-	27

*SS: Stainless Steel / Edelstahl

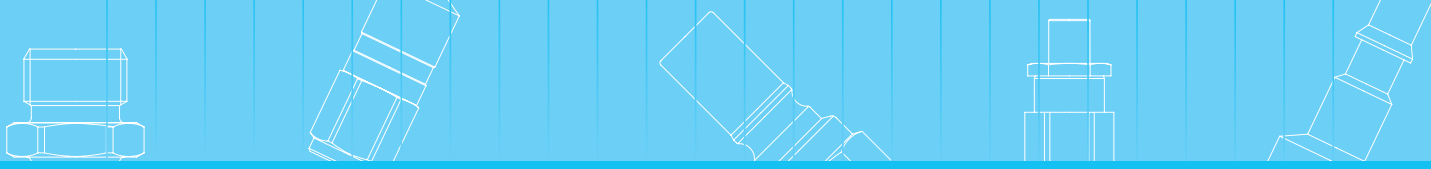

rtc[®]

QUICK CONNECT TECHNOLOGY
www.rtc-tec.com

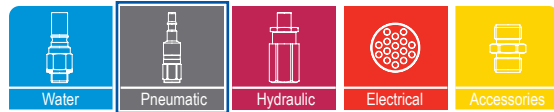

461.06

rtc TYPE





Compatible - Kompatibilität

rtc	170.06
rtc	171.06
rtc	173.06
rtc	450.06
rtc	451.06

Temperature Range - Temperaturbereich

Nitrile (N)	-20°C + 110°C (- 4°F + 230°F)
FPM (V)	-20°C + 180°C (- 4°F + 356°F)
EPDM (Ethylene Propylene)	-40°C + 150°C (- 40°F + 302°F)

Working Pressure - Betriebsdruck

25 Bar (360 PSI)

Connction / Disconnection Max. Pressure -

Ein- und Auskuppelbar bis Max. Druck
15 Bar (220 PSI)

Flow size - Nennweite

rtc type 461.06 5.5mm (1/4")

Standard version - Standardversion

Seals - Dichtung : Nitrile (N)

Material of Standard Coupler / Material für die Standardversion

Body / Housing - Kupplungsgrundkörper/Gehäuse	Steel tenifer threaded Stahl teneferiert
Inner Part / Cylinder - Innenteil / Zylinder	Surface hardened steel Zinc-nickel plated Stahl gehärtet, Zink-Nickel beschichtet
Back Part - Hinterteil Sleeve - Hülse	Steel zinc plated - Stahl verzinkt Zinc diecasted, nickel plated & orange plastic coated Zink-Druckguss, vernickelt und orange Gummi beschichtet
Springs - Federn	Stainless steel - Edelstahl
Seals - Dichtungen	Nitrile (N)
Plug - Nippel	Steel tenifer threaded Stahl teneferiert
Plug - Nippel	Steel tenifer threaded Stahl teneferiert

Advantages

- The system perfectly fits to the **ISO 4414**, **EN 983** safety requirements.
- Plug profile perfectly fits to the **ISO 6150-C-10**, **AFNOR C-10 NF E 49-053**
- Through flow, minimum pressure loss.
- Negligible Connecting Force
- Smart and Ergonomic features
- Ease of Handling
- Optimised Size

Vorteil

- Sicherheit gemäß **ISO 4414**, **EN 983**
- Stecknippel gemäß **ISO 6150-C-10**, **AFNOR C-10 NF E 49-053**
- Voller Durchgang, sehr geringer Druckverlust
- Einfache Bedienung, sehr geringe Kuppelkraft
- Kompakte Bauform



Flow Rate vs Pressure Drop Graph

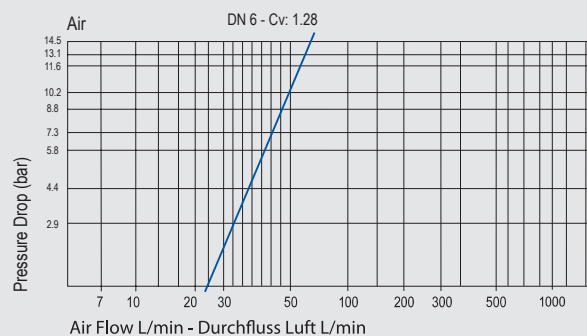

461.06
rtc TYPE

rtc TYPE 461.06

Male thread socket / Kupplung mit Aussengewinde



Socket / Kupplung

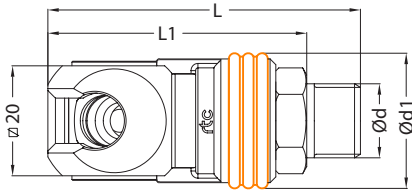

Size / Größe	Alternative Order No Alternative Bestellnr.	Order No / Bestellnr.	Ød	Ød1	L	L1	HEX.
6	R205 00 163	461.06 SMO 13	BSP 1/4	25	59.5	48.5	19
6	R205 00 164	461.06 SMO 17	BSP 3/8	25	59.5	48.5	19
6	R205 00 165	461.06 SMO 21	BSP 1/2	25	61.5	49.5	22
6	R205 00 166	461.06 STO 13	NPT 1/4	25	60.5	48.5	19
6	R205 00 167	461.06 STO 17	NPT 3/8	25	62.5	48.5	19
6	R205 00 168	461.06 STO 21	NPT 1/2	25	68.5	49.5	22

rtc TYPE 461.06

Female thread socket / Kupplung mit Innengewinde



Socket / Kupplung

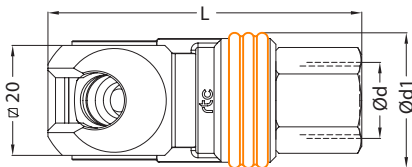

Size / Größe	Alternative Order No Alternative Bestellnr.	Order No / Bestellnr.	Ød	Ød1	L	L1	HEX.
6	R205 00 156	461.06 SFO 13	BSP 1/4	25	56.5	-	19
6	R205 00 157	461.06 SFO 17	BSP 3/8	25	58.5	-	20
6	R205 00 158	461.06 SFO 21	BSP 1/2	25	60.5	-	24
6	R205 00 160	461.06 SNO 13	NPT 1/4	25	57.5	-	19
6	R205 00 161	461.06 SNO 17	NPT 3/8	25	59.5	-	20
6	R205 00 162	461.06 SNO 21	NPT 1/2	25	65.5	-	24

rtc TYPE 461.06

Socket with hose barb / Kupplung mit Schlauchanschluss



Socket / Kupplung

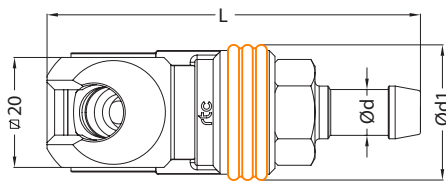

Size / Größe	Alternative Order No Alternative Bestellnr.	Order No / Bestellnr.	Ød	Ød1	L	L1	HEX.
6	R205 00 169	461.06 SHO 06	Ø6 - 1/4	25	69	-	-
6	R205 00 170	461.06 SHO 08	Ø8 - 5/16	25	69	-	-
6	R205 00 171	461.06 SHO 10	Ø10 - 3/8	25	69	-	-

rtc TYPE 461.06

Socket with plastic hose connection / Kupplung mit Kunststoffschlauchanschluss



Socket / Kupplung

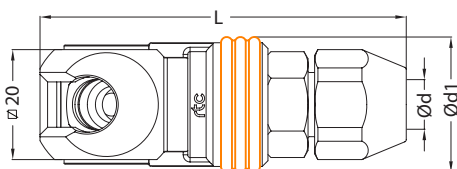

Size / Größe	Alternative Order No Alternative Bestellnr.	Order No / Bestellnr.	Ød	Ød1	L	L1	HEX.
6	R205 00 276	461.06 SVO 0610	6.5x10	25	70	-	22
6	R205 00 277	461.06 SVO 0812	8x12	25	70	-	22

Plug with male thread / Nippel mit Aussengewinde TYPE 461.06 **rtc**

Plug / Nippel	Size / Größe	Alternative Order No Alternative Bestellnr.	Order No / Bestellnr.	Ød	Ød1	L	L1	HEX.
	6	R255 00 093	461.06 PMF 10	BSP 1/8	-	44	36	14
	6	R255 00 091	461.06 PMF 13	BSP 1/4	-	47	36	14
	6	R255 00 092	461.06 PMF 17	BSP 3/8	-	52	40	19
	6	R255 00 111	461.06 PTF 10	NPT 1/8	-	44	36	14
	6	R255 00 112	461.06 PTF 13	NPT 1/4	-	47	45	14
	6	R255 00 117	461.06 PTF 17	NPT 3/8	-	53	48	19

Plug with female thread / Nippel mit Innengewinde TYPE 461.06 **rtc**

Plug / Nippel	Size / Größe	Alternative Order No Alternative Bestellnr.	Order No / Bestellnr.	Ød	Ød1	L	L1	HEX.
	6	R255 00 100	461.06 PFF 10	BSP 1/8	-	42	-	14
	6	R255 00 088	461.06 PFF 13	BSP 1/4	-	46.5	-	17
	6	-	461.06 PFF 17	BSP 3/8	-	50	-	22
	6	R255 00 118	461.06 PNF 10	NPT 1/8	-	42	-	14
	6	R255 00 119	461.06 PNF 13	NPT 1/4	-	46.5	-	17
	6	R255 00 286	461.06 PNF 17	NPT 3/8	-	51	-	22

Plug with hose barb / Nippel mit Schlauchanschluss TYPE 461.06 **rtc**

Plug / Nippel	Size / Größe	Alternative Order No Alternative Bestellnr.	Order No / Bestellnr.	Ød	Ød1	L	L1	HEX.
	6	R255 00 113	461.06 PHF 06	Ø6 - 1/4	12	56	-	-
	6	R255 00 114	461.06 PHF 08	Ø8 - 5/16	12	56	-	-
	6	R255 00 115	461.06 PHF 10	Ø10 - 3/8	13	56	-	-
	6	R255 00 116	461.06 PHF 13	Ø13 - 1/2	16.5	60	-	-

Plug with plastic hose connection / Nippel mit Kunststoffschlauchanschluss TYPE 461.06 **rtc**

Plug / Nippel	Size / Größe	Alternative Order No Alternative Bestellnr.	Order No / Bestellnr.	Ød	Ød1	L	L1	HEX.
	6	-	461.06 PVF 0610	6.5x10	-	65	-	22
	6	-	461.06 PVF 0812	8.0x12	-	65	-	22



rtc[®]

QUICK CONNECT TECHNOLOGY
www.rtc-tec.com

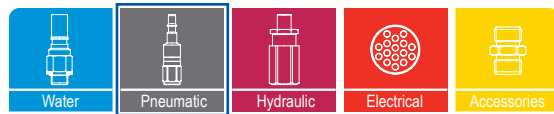

461.08

rtc TYPE





Compatible - Kompatibilität

rtc	170.08
rtc	171.08
rtc	173.08
rtc	450.08
rtc	451.08

Temperature Range - Temperaturbereich

Nitrile (N)	-20°C + 110°C (- 4°F + 230°F)
FPM (V)	-20°C + 180°C (- 4°F + 356°F)
EPDM (Ethylene Propylene)	-40°C + 150°C (- 40°F + 302°F)

Working Pressure - Betriebsdruck

25 Bar (360 PSI)

Connction / Disconnection Max. Pressure -

Ein- und Auskuppelbar bis Max. Druck
15 Bar (220 PSI)

Flow size - Nennweite

rtc type 461.08 8mm (3/8")

Standard version - Standardversion

Seals - Dichtung : Nitrile (N)

Material of Standard Coupler / Material für die Standardversion

Body / Housing -	Steel tenifer threated
Kupplungsgrundkörper/Gehäuse	Stahl teneferiert
Inner Part / Cylinder -	Surface hardened steel
	Zinc-nickel plated
Innenteil / Zylinder	Stahl gehärtet, Zink-Nickel beschichtet
Back Part - Hinterteil	Steel zinc plated - Stahl verzinkt
Sleeve -	Zinc diecasted, nickel plated & orange plastic coated
Hülse	Zink-Druckguss, vernickelt und orange Gummi beschichtet
Springs - Federn	Stainless steel - Edelstahl
Seals - Dichtungen	Nitrile (N)
Plug -	Steel Tenifer Threated
Nippel	Stahl Teneferiert
Plug -	Steel tenifer threated
Nippel	Stahl teneferiert

Advantages

- The system perfectly fits to the ISO 4414, EN 983 safety requirements.
- Plug profile perfectly fits to the ISO 6150-C-14, AFNOR C-14 NF E 49-053
- Through flow, minimum pressure loss.
- Negligible Connecting Force
- Smart and Ergonomic features
- Ease of Handling
- Optimised Size

Vorteil

- Sicherheit gemäß ISO 4414, EN 983
- Stecknippel gemäß ISO 6150-C-14, AFNOR C-14 NF E 49-053
- Voller Durchgang, sehr geringer Druckverlust
- Einfache Bedienung, sehr geringe Kuppelkraft
- Kompakte Bauform



Flow Rate vs Pressure Drop Graph

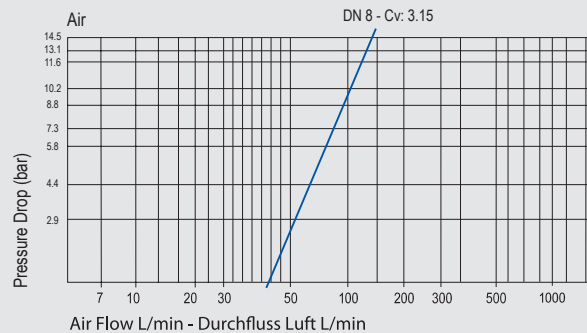

461.08
rtc TYPE

rtc TYPE 461.08

Male thread socket / Kupplung mit Aussengewinde



Socket / Kupplung

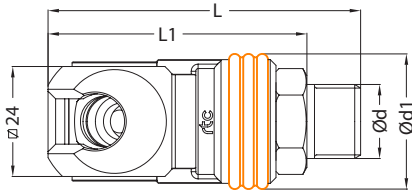

Size / Größe	Alternative Order No Alternative Bestellnr.	Order No / Bestellnr.	Ød	Ød1	L	L1	HEX.
8	R205 00 121	461.08 SMO 13	BSP 1/4	30	69.5	58.5	20
8	R205 00 122	461.08 SMO 17	BSP 3/8	30	69.5	58.5	20
8	R205 00 123	461.08 SMO 21	BSP 1/2	30	71.5	59.5	22
8	R205 00 283	461.08 STO 13	NPT 1/4	30	70.5	56.5	20
8	R205 00 124	461.08 STO 17	NPT 3/8	30	71.5	57.5	20
8	R205 00 125	461.08 STO 21	NPT 1/2	30	78.5	59.5	22

rtc TYPE 461.08

Female thread socket / Kupplung mit Innengewinde



Socket / Kupplung

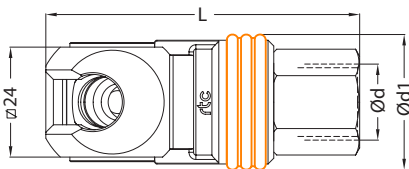

Size / Größe	Alternative Order No Alternative Bestellnr.	Order No / Bestellnr.	Ød	Ød1	L	L1	HEX.
8	R205 00 115	461.08 SFO 13	BSP 1/4	30	68.5	-	20
8	R205 00 116	461.08 SFO 17	BSP 3/8	30	68.5	-	20
8	R205 00 117	461.08 SFO 21	BSP 1/2	30	69.5	-	24
8	R205 00 118	461.08 SNO 13	NPT 1/4	30	68.5	-	20
8	R205 00 119	461.08 SNO 17	NPT 3/8	30	68.5	-	20
8	R205 00 120	461.08 SNO 21	NPT 1/2	30	69.5	-	24

rtc TYPE 461.08

Socket with hose barb / Kupplung mit Schlauchanschluss



Socket / Kupplung

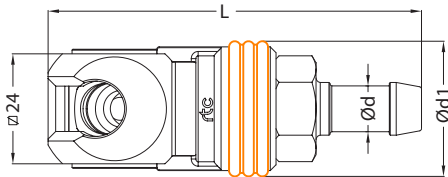

Size / Größe	Alternative Order No Alternative Bestellnr.	Order No / Bestellnr.	Ød	Ød1	L	L1	HEX.
8	R205 00 126	461.08 SHO 08	Ø8 - 5/16	30	79	-	-
8	R205 00 127	461.08 SHO 10	Ø10 - 3/8	30	79	-	-
8	R205 00 128	461.08 SHO 13	Ø13 - 1/2	30	79	-	-

rtc TYPE 461.08

Socket with plastic hose connection / Kupplung mit Kunststoffschlauchanschluss



Socket / Kupplung

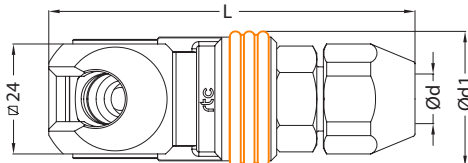

Size / Größe	Alternative Order No Alternative Bestellnr.	Order No / Bestellnr.	Ød	Ød1	L	L1	HEX.
8	R205 00 129	461.08 SVO 0610	6.5x10	30	80	-	22
8	R205 00 130	461.08 SVO 0812	8x12	30	80	-	22
8	R205 00 131	461.08 SVO 1116	11x16	30	84	-	27

Plug with male thread / Nippel mit Aussengewinde TYPE 461.08 **rtc**

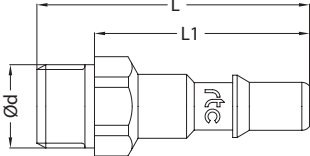
Plug / Nippel	Size / Größe	Alternative Order No Alternative Bestellnr.	Order No / Bestellnr.	Ød	Ød1	L	L1	HEX.
	8	R255 00 101	461.08 PMF 13	BSP 1/4	-	55	44	17
	8	R255 00 102	461.08 PMF 17	BSP 3/8	-	57	44.5	19
	8	-	461.08 PMF 21	BSP 1/2	-	60	48	24
	8	R255 00 090	461.08 PTF 13	NPT 1/4	-	57	44.5	17
	8	R255 00 089	461.08 PTF 17	NPT 3/8	-	57	44.5	19
	8	R255 00 359	461.08 PTF 21	NPT 1/2	-	64	47	24

Plug with female thread / Nippel mit Innengewinde TYPE 461.08 **rtc**

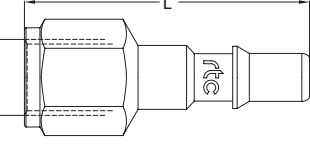
Plug / Nippel	Size / Größe	Alternative Order No Alternative Bestellnr.	Order No / Bestellnr.	Ød	Ød1	L	L1	HEX.
	8	R255 00 103	461.08 PFF 13	BSP 1/4	-	55.5	-	17
	8	R255 00 105	461.08 PFF 17	BSP 3/8	-	57.5	-	22
	8	-	461.08 PFF 21	BSP 1/2	-	59	-	27
	8	R255 00 104	461.08 PNF 13	NPT 1/4	-	56.5	-	17
	8	R255 00 106	461.08 PNF 17	NPT 3/8	-	57.5	-	22
	8	-	461.08 PNF 21	NPT 1/2	-	59	-	27

Plug with hose barb / Nippel mit Schlauchanschluss TYPE 461.08 **rtc**

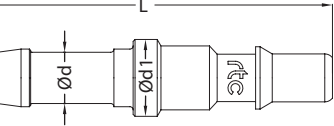
Plug / Nippel	Size / Größe	Alternative Order No Alternative Bestellnr.	Order No / Bestellnr.	Ød	Ød1	L	L1	HEX.
	8	R255 00 107	461.08 PHF 08	Ø8 - 5/16	15	62	-	-
	8	R255 00 108	461.08 PHF 10	Ø10 - 3/8	15	62	-	-
	8	R255 00 109	461.08 PHF 13	Ø13 - 1/2	17	66	-	-
	8	R255 00 110	461.08 PHF 16	Ø16 - 5/8	19	66	-	-

Plug with plastic hose connection / Nippel mit Kunststoffschlauchanschluss TYPE 461.08 **rtc**

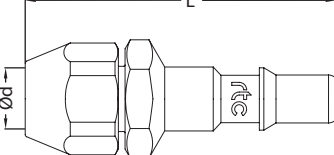
Plug / Nippel	Size / Größe	Alternative Order No Alternative Bestellnr.	Order No / Bestellnr.	Ød	Ød1	L	L1	HEX.
	8	-	461.08 PVF 0812	8x12	-	72	-	22
	8	-	461.08 PVF 1116	11x16	-	77	-	27



rtc[®]

QUICK CONNECT TECHNOLOGY
www.rtc-tec.com

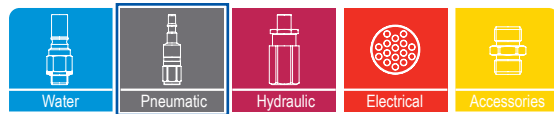

461.11

rtc TYPE



Compatible - Kompatibilität

rtc	170.11
rtc	171.11
rtc	173.11
rtc	450.11
rtc	451.11

Temperature Range - Temperaturbereich

Nitrile (N)	-20°C + 110°C (-4°F + 230°F)
FPM (V)	-20°C + 180°C (-4°F + 356°F)
EPDM (Ethylene Propylene)	-40°C + 150°C (-40°F + 302°F)

Working Pressure - Betriebsdruck

25 Bar (360 PSI)

Connction / Disconnection Max. Pressure -

Ein- und Auskuppelbar bis Max. Druck
15 Bar (220 PSI)

Flow size - Nennweite

rtc type 461.11 11mm (1/2")

Standard version - Standardversion

Seals - Dichtung : Nitrile (N)

Material of Standard Coupler / Material für die Standardversion

Body / Housing - Kupplungsgrundkörper/Gehäuse	Steel tenifer threaded Stahl teneferiert
Inner Part / Cylinder - Innenteil / Zylinder	Surface hardened steel Zinc-nickel plated Stahl gehärtet, Zink-Nickel beschichtet
Back Part - Hinterteil Sleeve - Hülse	Steel zinc plated - Stahl verzinkt Steel zinc nickel plated & orange painted Stahl Zink-Nickel Beschichtet und orange lackiert
Springs - Federn Seals - Dichtungen	Stainless steel - Edelstahl Nitrile (N)
Plug - Nippel	Steel tenifer threaded Stahl teneferiert

Advantages

- The system perfectly fits to the ISO 4414, EN 983 safety requirements.
- Plug profile perfectly fits to the ISO 6150-C-17, AFNOR C-17 NF E 49-053
- Through flow, minimum pressure loss.
- Negligible Connecting Force
- Smart and Ergonomic features
- Ease of Handling
- Optimised Size

Vorteil

- Sicherheit gemäß ISO 4414, EN 983
- Stecknippel gemäß ISO 6150-C-17, AFNOR C-17 NF E 49-053
- Voller Durchgang, sehr geringer Druckverlust
- Einfache Bedienung, sehr geringe Kuppelkraft
- Kompakte Bauform



Flow Rate vs Pressure Drop Graph

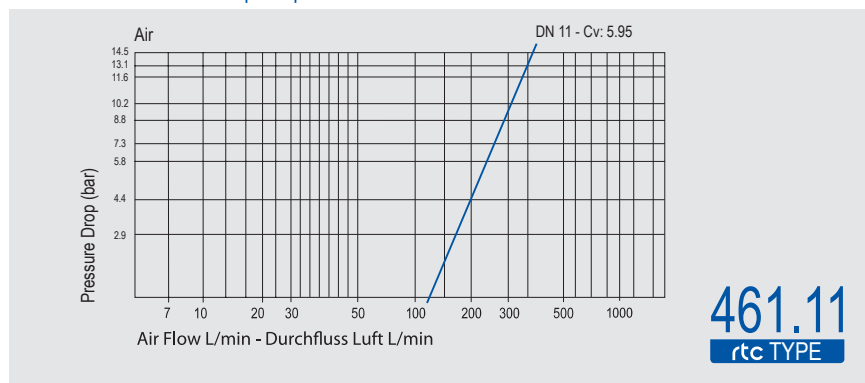

rtc TYPE 461.11

Male thread socket / Kupplung mit Aussengewinde



Socket / Kupplung

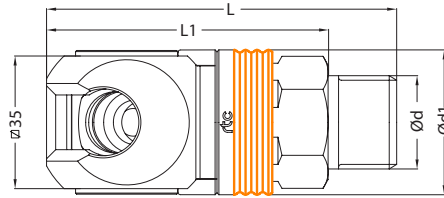

Size / Größe	Alternative Order No Alternative Bestellnr.	Order No / Bestellnr.	Ød	Ød1	L	L1	HEX.
11	R205 00 135	461.11 SMO 17	BSP 3/8	38	81.5	70.5	30
11	R205 00 136	461.11 SMO 21	BSP 1/2	38	82.5	70.5	30
11	R205 00 137	461.11 SMO 26	BSP 3/4	38	85.5	70.5	30
11	R205 00 141	461.11 STO 17	NPT 3/8	38	85.5	70.5	30
11	R205 00 142	461.11 STO 21	NPT 1/2	38	88.5	70.5	30
11	R205 00 143	461.11 STO 26	NPT 3/4	38	89.5	70.5	30

rtc TYPE 461.11

Female thread socket / Kupplung mit Innengewinde



Socket / Kupplung

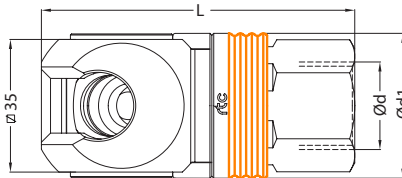

Size / Größe	Alternative Order No Alternative Bestellnr.	Order No / Bestellnr.	Ød	Ød1	L	L1	HEX.
11	R205 00 132	461.11 SFO 17	BSP 3/8	38	79	-	30
11	R205 00 133	461.11 SFO 21	BSP 1/2	38	80.5	-	30
11	R205 00 134	461.11 SFO 26	BSP 3/4	38	83.5	-	32
11	R205 00 138	461.11 SNO 17	NPT 3/8	38	79	-	30
11	R205 00 139	461.11 SNO 21	NPT 1/2	38	80.5	-	30
11	R205 00 140	461.11 SNO 26	NPT 3/4	38	83.5	-	32

rtc TYPE 461.11

Socket with hose barb / Kupplung mit Schlauchanschluss



Socket / Kupplung

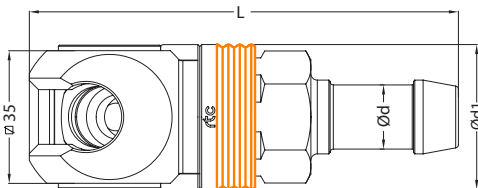

Size / Größe	Alternative Order No Alternative Bestellnr.	Order No / Bestellnr.	Ød	Ød1	L	L1	HEX.
11	-	461.11 SHO 10	Ø10 - 3/8	38	96.5	-	-
11	R205 00 737	461.11 SHO 13	Ø13 - 1/2	38	96.5	-	-
11	-	461.11 SHO 16	Ø16 - 5/8	38	96.5	-	-

rtc TYPE 461.11

Socket with plastic hose connection / Kupplung mit Kunststoffschlauchanschluss



Socket / Kupplung

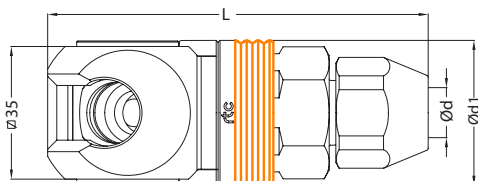

Size / Größe	Alternative Order No Alternative Bestellnr.	Order No / Bestellnr.	Ød	Ød1	L	L1	HEX.
11	-	461.11 SVO 0812	8x12	38	93	-	22
11	-	461.11 SVO 1116	11x16	38	93	-	27

Plug with male thread / Nippel mit Aussengewinde TYPE 461.11 **rtc**

Plug / Nippel	Size / Größe	Alternative Order No Alternative Bestellnr.	Order No / Bestellnr.	Ød	Ød1	L	L1	HEX.
	11	R255 00 131	461.11 PMF 17	BSP 3/8	-	63	51	19
	11	R255 00 132	461.11 PMF 21	BSP 1/2	-	68	53	24
	11	R255 00 133	461.11 PMF 26	BSP 3/4	-	70	53	30
	11	R255 00 137	461.11 PTF 17	NPT 3/8	-	62	51	19
	11	R255 00 138	461.11 PTF 21	NPT 1/2	-	67	50	24
	11	R255 00 139	461.11 PTF 26	NPT 3/4	-	70	51	27

Plug with female thread / Nippel mit Innengewinde TYPE 461.11 **rtc**

Plug / Nippel	Size / Größe	Alternative Order No Alternative Bestellnr.	Order No / Bestellnr.	Ød	Ød1	L	L1	HEX.
	11	R255 00 128	461.11 PFF 17	BSP 3/8	-	62	-	22
	11	R255 00 129	461.11 PFF 21	BSP 1/2	-	66	-	27
	11	R255 00 130	461.11 PFF 26	BSP 3/4	-	69	-	32
	11	R255 00 134	461.11 PNF 17	NPT 3/8	-	62	-	22
	11	R255 00 135	461.11 PNF 21	NPT 1/2	-	67	-	27
	11	R255 00 136	461.11 PNF 26	NPT 3/4	-	69	-	32

Plug with hose barb / Nippel mit Schlauchanschluss TYPE 461.11 **rtc**

Plug / Nippel	Size / Größe	Alternative Order No Alternative Bestellnr.	Order No / Bestellnr.	Ød	Ød1	L	L1	HEX.
	11	R255 00 140	461.11 PHF 10	Ø10 - 3/8	19	70.5	-	-
	11	R255 00 141	461.11 PHF 13	Ø13 - 1/2	19	70.5	-	-
	11	R255 00 142	461.11 PHF 16	Ø16 - 5/8	21	72	-	-
	11	R255 00 143	461.11 PHF 19	Ø19 - 3/4	23	85	-	-

Plug with plastic hose connection / Nippel mit Kunststoffschlauchanschluss TYPE 461.11 **rtc**

Plug / Nippel	Size / Größe	Alternative Order No Alternative Bestellnr.	Order No / Bestellnr.	Ød	Ød1	L	L1	HEX.
	11	-	461.11 PVF 0812	8x12	-	72	-	22
	11	-	461.11 PVF 1116	11x16	-	76	-	27



rtc[®]

QUICK CONNECT TECHNOLOGY
www.rtc-tec.com

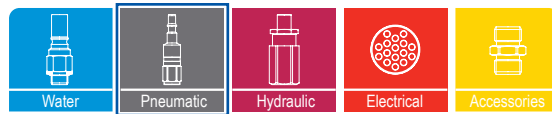

461.19

rtc TYPE





Compatible - Kompatibilität
rtc 170.19

Temperature Range - Temperaturbereich

Nitrile (N)	-20°C + 110°C (-4°F + 230°F)
FPM (V)	-20°C + 180°C (-4°F + 356°F)
EPDM (Ethylene Propylene)	-40°C + 150°C (-40°F + 302°F)

Working Pressure - Betriebsdruck
25 Bar (360 PSI)

Connction / Disconnection Max. Pressure - Ein- und Auskuppelbar bis Max. Druck
12 Bar (175 PSI)

Flow size - Nennweite
rtc type 461.19 19mm (3/4")

Standard version - Standardversion
Seals - Dichtung : Nitrile (N)

Material of Standard Coupler / Material für die Standardversion

Body / Housing - Kupplungsgrundkörper/Gehäuse	Steel tenifer threaded / Stahl teneferiert
Inner Part / Cylinder - Innenteil / Zylinder	Surface hardened steel / Stahl gehärtet, Zink-Nickel beschichtet
Back Part - Hinterteil Sleeve - Hülse	Steel zinc plated - Stahl verzinkt / Steel zinc nickel plated & orange painted / Stahl Zink-Nickel beschichtet und orange lackiert
Springs - Federn	Stainless steel - Edelstahl
Seals - Dichtungen	Nitrile (N)
Plug - Nippel	Steel tenifer threaded / Stahl teneferiert

Advantages

- The system perfectly fits to the **ISO 4414, EN 983** safety requirements.
- Plug profile perfectly fits to the **ISO 6150-C-27, AFNOR C-27 NF E 49-053**
- Through flow, minimum pressure loss.
- Negligible Connecting Force
- Smart and Ergonomic features
- Ease of Handling
- Optimised Size

Vorteil

- Sicherheit gemäß **ISO 4414, EN 983**
- Stecknippel gemäß **ISO 6150-C-27, AFNOR C-27 NF E 49-053**
- Voller Durchgang, sehr geringer Druckverlust
- Einfache Bedienung, sehr geringe Kuppelkraft
- Kompakte Bauform



Flow Rate vs Pressure Drop Graph

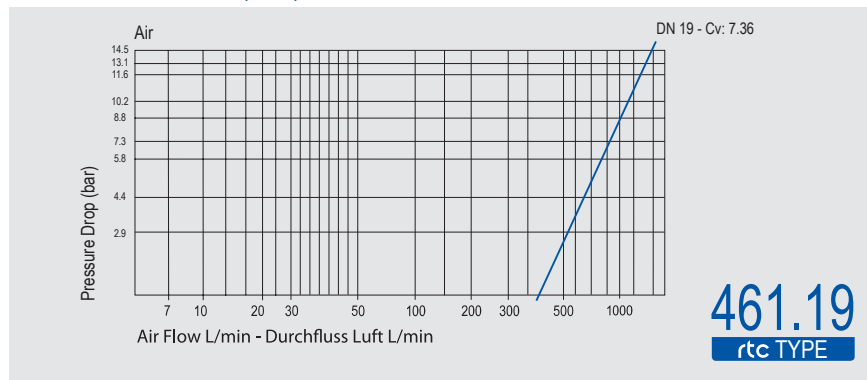

rtc TYPE 461.19

Male thread socket / Kupplung mit Aussengewinde



Socket / Kupplung

Socket / Kupplung	Size / Größe	Alternative Order No Alternative Bestellnr.	Order No / Bestellnr.	Ød	Ød1	L	L1	HEX.
	19	R205 00 146	461.19 SMO 26	BSP 3/4	64	163	146	55
	19	R205 00 147	461.19 SMO 33	BSP 1	64	167	147	55
	19	R205 00 150	461.19 STO 26	NPT 3/4	64	169	150	55
	19	R205 00 151	461.19 STO 33	NPT 1	64	175	151	55

rtc TYPE 461.19

Female thread socket / Kupplung mit Innengewinde



Socket / Kupplung

Socket / Kupplung	Size / Größe	Alternative Order No Alternative Bestellnr.	Order No / Bestellnr.	Ød	Ød1	L	L1	HEX.
	19	R205 00 144	461.19 SFO 26	BSP 3/4	64	144	-	55
	19	R205 00 145	461.19 SFO 33	BSP 1	64	145	-	55
	19	R205 00 148	461.19 SNO 26	NPT 3/4	64	148	-	55
	19	R205 00 149	461.19 SNO 33	NPT 1	64	149	-	55

Plug with male thread / Nippel mit Aussengewinde

TYPE 461.19 **rtc**

Plug / Nippel	Size / Größe	Alternative Order No Alternative Bestellnr.	Order No / Bestellnr.	Ød	Ød1	L	L1	HEX.
	19	R255 00 082	461.19 PMF 26	BSP 3/4	-	95	81	36
	19	R255 00 083	461.19 PMF 33	BSP 1	-	99	81	36
	19	R255 00 281	461.19 PTF 26	NPT 3/4	-	100	81	36
	19	R255 00 282	461.19 PTF 33	NPT 1	-	105	81	36

Plug with female thread / Nippel mit Innengewinde

TYPE 461.19 **rtc**

Plug / Nippel	Size / Größe	Alternative Order No Alternative Bestellnr.	Order No / Bestellnr.	Ød	Ød1	L	L1	HEX.
	19	R255 00 084	461.19 PFF 26	BSP 3/4	-	-	89	36
	19	R255 00 085	461.19 PFF 33	BSP 1	-	-	94	41
	19	R255 00 283	461.19 PNF 26	NPT 3/4	-	-	89	36
	19	R255 00 284	461.19 PNF 33	NPT 1	-	-	94	41

Plug with hose barb / Nippel mit Schlauchanschluss

TYPE 461.19 **rtc**

Plug / Nippel	Size / Größe	Alternative Order No Alternative Bestellnr.	Order No / Bestellnr.	Ød	Ød1	L	L1	HEX.
	19	R255 00 086	461.19 PHF 19	Ø19 - 3/4	30	105.5	-	-
	19	R255 00 087	461.19 PHF 25	Ø25 - 1	35	118.5	-	-



rtc[®]

QUICK CONNECT TECHNOLOGY
www.rtc-tec.com

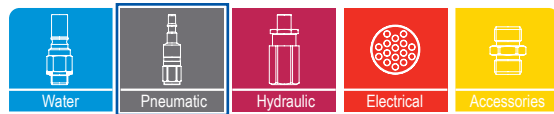

462.06

rtc TYPE





Compatible - Kompatibilität

rtc	014
rtc	022
ARO	210
Cejn	300
Parker	B53
Rectus	14 & 22
Foster	210
AMFLO	C38

Temperature Range - Temperaturbereich

Nitrile (N)	-20°C + 110°C (- 4°F + 230°F)
FPM (V)	-20°C + 180°C (- 4°F + 356°F)
EPDM (Ethylene Propylene)	-40°C + 150°C (- 40°F + 302°F)

Working Pressure - Betriebsdruck

25 Bar (360 PSI)

Connction / Disconnection Max. Pressure -

Ein- und Auskuppelbar bis Max. Druck
15 Bar (220 PSI)

Flow size - Nennweite

rtc type 462.06 5.5mm (1/4")

Standard version - Standardversion

Seals - Dichtung : Nitrile (N)

Material of Standard Coupler / Material für die Standardversion

Body / Housing - Kupplungsgrundkörper/Gehäuse	Steel tenifer threated Stahl teneferiert
Inner Part / Cylinder - Innenteil / Zylinder	Surface hardened steel Zinc-nickel plated Stahl gehärtet, Zink-Nickel beschichtet
Back Part - Hinterteil Sleeve -	Steel zinc plated - Stahl verzinkt Zinc diecasted, nickel plated & orange plastic coated
Hülse	Zinc-Druckguss, vernickelt und orange Gummi beschichtet
Springs - Federn Seals - Dichtungen	Stainless steel - Edelstahl Nitrile (N)
Plug - Nippel	Surface hardened steel, galvanized Stahl gehärtet, verzinkt

Advantages

- The system perfectly fits to the ISO 4414, EN 983 safety requirements.
- Through flow, minimum pressure loss.
- Negligible Connecting Force
- Smart and Ergonomic features
- Ease of Handling
- Optimised Size

Vorteil

- Sicherheit gemäß ISO 4414, EN 983
- Voller Durchgang, sehr geringer Druckverlust
- Einfache Bedienung, sehr geringe Kuppelkraft
- Kompakte Bauform



Flow Rate vs Pressure Drop Graph

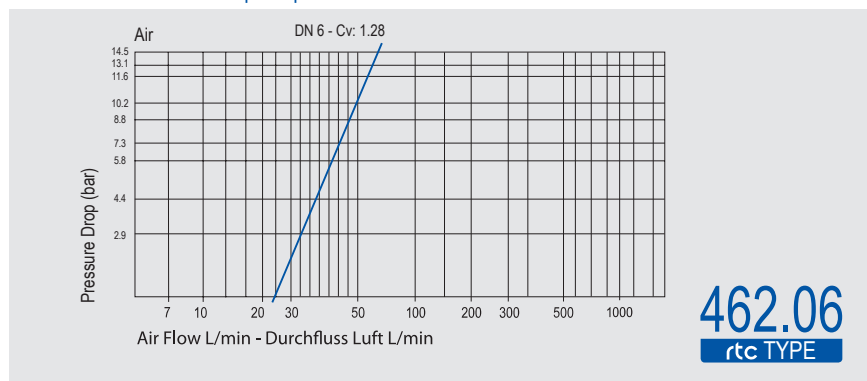

rtc TYPE 462.06

Male thread socket / Kupplung mit Aussengewinde



Socket / Kupplung

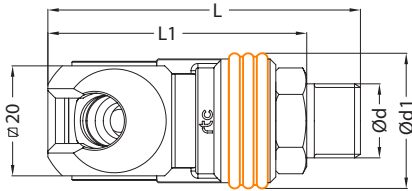

Size / Größe	Alternative Order No Alternative Bestellnr.	Order No / Bestellnr.	Ød	Ød1	L	L1	HEX.
6	R205 00 294	462.06 SMO 13	BSP 1/4	25	59.5	48.5	19
6	R205 00 295	462.06 SMO 17	BSP 3/8	25	59.5	48.5	19
6	R205 00 296	462.06 SMO 21	BSP 1/2	25	61.5	49.5	22
6	R205 00 297	462.06 STO 13	NPT 1/4	25	60.5	48.5	19
6	R205 00 298	462.06 STO 17	NPT 3/8	25	62.5	48.5	19
6	R205 00 299	462.06 STO 21	NPT 1/2	25	68.5	49.5	22

rtc TYPE 462.06

Female thread socket / Kupplung mit Innengewinde



Socket / Kupplung

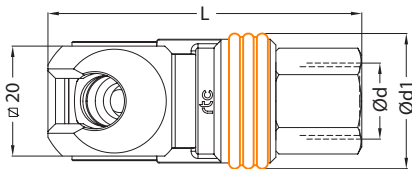

Size / Größe	Alternative Order No Alternative Bestellnr.	Order No / Bestellnr.	Ød	Ød1	L	L1	HEX.
6	R205 00 286	462.06 SFO 10	BSP 1/8	25	56.5	-	19
6	R205 00 287	462.06 SFO 13	BSP 1/4	25	56.5	-	19
6	R205 00 288	462.06 SFO 17	BSP 3/8	25	58.5	-	19
6	R205 00 289	462.06 SFO 21	BSP 1/2	25	60.5	-	24
6	R205 00 290	462.06 SNO 10	NPT 1/8	25	57.5	-	19
6	R205 00 291	462.06 SNO 13	NPT 1/4	25	57.5	-	19
6	R205 00 292	462.06 SNO 17	NPT 3/8	25	59.5	-	20
6	R205 00 293	462.06 SNO 21	NPT 1/2	25	65.5	-	24

rtc TYPE 462.06

Socket with hose barb / Kupplung mit Schlauchanschluss



Socket / Kupplung

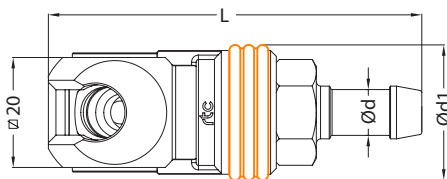

Size / Größe	Alternative Order No Alternative Bestellnr.	Order No / Bestellnr.	Ød	Ød1	L	L1	HEX.
6	R205 00 300	462.06 SHO 06	Ø6 - 1/4	25	69	-	-
6	R205 00 301	462.06 SHO 08	Ø8 - 5/16	25	69	-	-
6	R205 00 302	462.06 SHO 10	Ø10 - 3/8	25	69	-	-

rtc TYPE 462.06

Socket with plastic hose connection / Kupplung mit Kunststoffschlauchanschluss



Socket / Kupplung

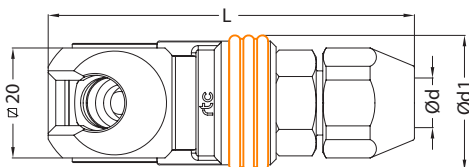

Size / Größe	Alternative Order No Alternative Bestellnr.	Order No / Bestellnr.	Ød	Ød1	L	L1	HEX.
6	R205 00 304	462.06 SVO 0610	6.5x10	25	70	-	22
6	R205 00 305	462.06 SVO 0812	8x12	25	70	-	22

Plug with male thread / Nippel mit Aussengewinde TYPE 462.06 

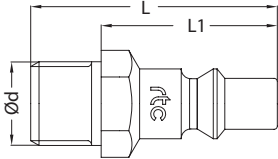
Plug / Nippel	Size / Größe	Alternative Order No Alternative Bestellnr.	Order No / Bestellnr.	Ød	Ød1	L	L1	HEX.
	6	R255 00 000	462.06 PMF 10	BSP 1/8	-	36.5	30.5	14
	6	R255 00 001	462.06 PMF 13	BSP 1/4	-	40.5	30.5	17
	6	-	462.06 PMF 17	BSP 3/8	-	42	33.5	19
	6	R255 00 002	462.06 PTF 10	NPT 1/8	-	39.5	30.5	14
	6	R255 00 003	462.06 PTF 13	NPT 1/4	-	42.5	30.5	17
	6	R255 00 066	462.06 PTF 17	NPT 3/8	-	45.5	33.5	19

Plug with female thread / Nippel mit Innengewinde TYPE 462.06 

Plug / Nippel	Size / Größe	Alternative Order No Alternative Bestellnr.	Order No / Bestellnr.	Ød	Ød1	L	L1	HEX.
	6	R255 00 004	462.06 PFF 10	BSP 1/8	-	37.5	-	14
	6	R255 00 005	462.06 PFF 13	BSP 1/4	-	40.5	-	17
	6	-	462.06 PFF 17	BSP 3/8	-	41.5	-	19
	6	R255 00 006	462.06 PNF 10	NPT 1/8	-	37.5	-	14
	6	R255 00 007	462.06 PNF 13	NPT 1/4	-	41.5	-	17
	6	R255 00 068	462.06 PNF 17	NPT 3/8	-	42.5	-	19

Plug with hose barb / Nippel mit Schlauchanschluss TYPE 462.06 

Plug / Nippel	Size / Größe	Alternative Order No Alternative Bestellnr.	Order No / Bestellnr.	Ød	Ød1	L	L1	HEX.
	6	R255 00 008	462.06 PHF 06	Ø6 - 1/4	14	51	-	-
	6	R255 00 009	462.06 PHF 08	Ø8 - 5/16	14	51	-	-
	6	R255 00 010	462.06 PHF 10	Ø10 - 3/8	14	51	-	-

Plug with plastic hose connection / Nippel mit Kunststoffschlauchanschluss TYPE 462.06 

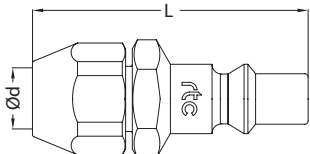
Plug / Nippel	Size / Größe	Alternative Order No Alternative Bestellnr.	Order No / Bestellnr.	Ød	Ød1	L	L1	HEX.
	6	-	462.06 PVF 0610	6.5x10	-	54	-	22
	6	-	462.06 PVF 0812	8x12	-	54	-	22

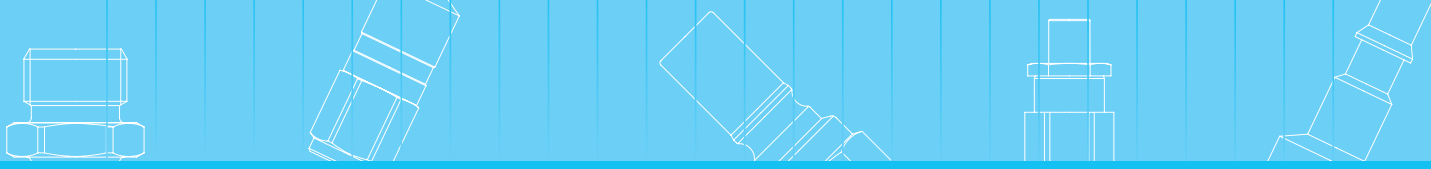

rtc[®]

QUICK CONNECT TECHNOLOGY
www.rtc-tec.com

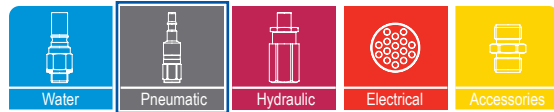

463.08

rtc TYPE



Compatible - Kompatibilität

rtc	025
rtc	026
Cejn	320
Rectus	25 & 26

Temperature Range - Temperaturbereich

Nitrile (N)	-20°C + 110°C (- 4°F + 230°F)
FPM (V)	-20°C + 180°C (- 4°F + 356°F)
EPDM (Ethylene Propylene)	-40°C + 150°C (- 40°F + 302°F)

Working Pressure - Betriebsdruck

25 Bar (360 PSI)

Connction / Disconnection Max. Pressure -

Ein- und Auskuppelbar bis Max. Druck
15 Bar (220 PSI)

Flow size - Nennweite

rtc type 463.08 7.8mm (3/8")

Standard version - Standardversion

Seals - Dichtung : Nitrile (N)

Material of Standard Coupler / Material für die Standardversion

Body / Housing -	Steel tenifer threated
Kupplungsgrundkörper/Gehäuse	Stahl teneferiert
Inner Part / Cylinder -	Surface hardened steel
	Zinc-nickel plated
Innenteil / Zylinder	Stahl gehärtet, Zink-Nickel beschichtet
Back Part - Hinterteil	Steel zinc plated - Stahl verzinkt
Sleeve -	Zinc diecasted, nickel plated & orange plastic coated
Hülse	Zink-Druckguss, vernickelt und orange Gummi beschichtet
Springs - Federn	Stainless steel - Edelstahl
Seals - Dichtungen	Nitrile (N)
Plug -	Surface hardened steel, galvanized
Nippel	Stahl gehärtet, verzinkt

Advantages

- The system perfectly fits to the ISO 4414, EN 983 safety requirements.
- Through flow, minimum pressure loss.
- Negligible Connecting Force
- Smart and Ergonomic features
- Ease of Handling
- Optimised Size

Vorteil

- Sicherheit gemäß ISO 4414, EN 983
- Voller Durchgang, sehr geringer Druckverlust
- Einfache Bedienung, sehr geringe Kuppelkraft
- Kompakte Bauform



Flow Rate vs Pressure Drop Graph

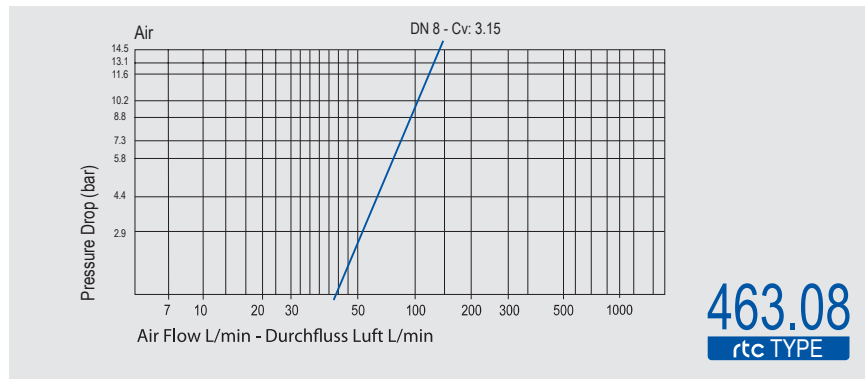

rtc TYPE 463.08

Male thread socket / Kupplung mit Aussengewinde



Socket / Kupplung

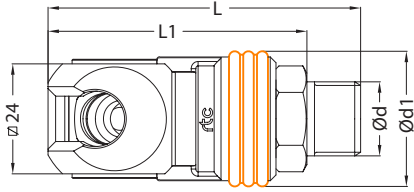

Size / Größe	Alternative Order No Alternative Bestellnr.	Order No / Bestellnr.	Ød	Ød1	L	L1	HEX.
8	R205 00 351	463.08 SMO 13	BSP 1/4	30	69.5	58.5	20
8	R205 00 352	463.08 SMO 17	BSP 3/8	30	69.5	58.5	20
8	R205 00 353	463.08 SMO 21	BSP 1/2	30	71.5	59.5	22
8	R205 00 375	463.08 STO 13	NPT 1/4	30	70.5	56.5	20
8	R205 00 354	463.08 STO 17	NPT 3/8	30	71.5	57.5	20
8	R205 00 355	463.08 STO 21	NPT 1/2	30	78.5	59.5	22

rtc TYPE 463.08

Female thread socket / Kupplung mit Innengewinde



Socket / Kupplung

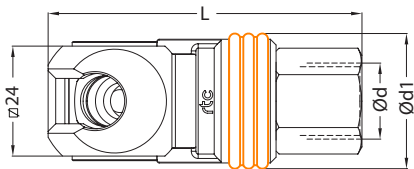

Size / Größe	Alternative Order No Alternative Bestellnr.	Order No / Bestellnr.	Ød	Ød1	L	L1	HEX.
8	R205 00 345	463.08 SFO 13	BSP 1/4	30	68.5	-	20
8	R205 00 346	463.08 SFO 17	BSP 3/8	30	68.5	-	20
8	R205 00 347	463.08 SFO 21	BSP 1/2	30	69.5	-	24
8	R205 00 348	463.08 SNO 13	NPT 1/4	30	68.5	-	20
8	R205 00 349	463.08 SNO 17	NPT 3/8	30	68.5	-	20
8	R205 00 350	463.08 SNO 21	NPT 1/2	30	69.5	-	24

rtc TYPE 463.08

Socket with hose barb / Kupplung mit Schlauchanschluss



Socket / Kupplung

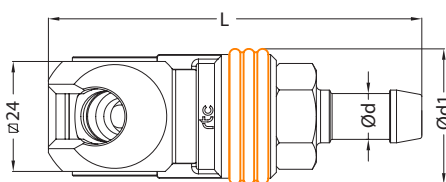

Size / Größe	Alternative Order No Alternative Bestellnr.	Order No / Bestellnr.	Ød	Ød1	L	L1	HEX.
8	R205 00 356	463.08 SHO 08	Ø8 - 5/16	30	79	-	-
8	R205 00 357	463.08 SHO 10	Ø10 - 3/8	30	79	-	-
8	R205 00 358	463.08 SHO 13	Ø13 - 1/2	30	79	-	-

rtc TYPE 463.08

Socket with plastic hose connection / Kupplung mit Kunststoffschlauchanschluss



Socket / Kupplung

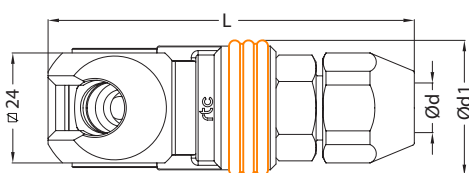

Size / Größe	Alternative Order No Alternative Bestellnr.	Order No / Bestellnr.	Ød	Ød1	L	L1	HEX.
8	R205 00 359	463.08 SVO 0610	6.5x10	30	80	-	22
8	R205 00 360	463.08 SVO 0812	8x12	30	80	-	22
8	R205 00 361	463.08 SVO 1116	11x16	30	84	-	27

Plug with male thread / Nippel mit Aussengewinde TYPE 463.08 **rtc**

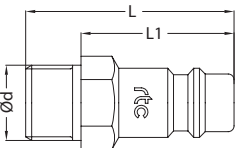
Plug / Nippel	Size / Größe	Alternative Order No Alternative Bestellnr.	Order No / Bestellnr.	Ød	Ød1	L	L1	HEX.
	8	R255 00 023	463.08 PMF 13	BSP 1/4	-	37	26	14
	8	R255 00 024	463.08 PMF 17	BSP 3/8	-	38.5	27.5	19
	8	R255 00 025	463.08 PMF 21	BSP 1/2	-	43	30	22
	8	R255 00 275	463.08 PTF 13	NPT 1/4	-	38	26	14
	8	R255 00 177	463.08 PTF 17	NPT 3/8	-	39.5	27.5	17
	8	R255 00 175	463.08 PTF 21	NPT 1/2	-	47	30	22

Plug with female thread / Nippel mit Innengewinde TYPE 463.08 **rtc**

Plug / Nippel	Size / Größe	Alternative Order No Alternative Bestellnr.	Order No / Bestellnr.	Ød	Ød1	L	L1	HEX.
	8	R255 00 026	463.08 PFF 13	BSP 1/4	-	38	-	17
	8	R255 00 027	463.08 PFF 17	BSP 3/8	-	39	-	19
	8	R255 00 028	463.08 PFF 21	BSP 1/2	-	43	-	24
	8	R255 00 276	463.08 PNF 13	NPT 1/4	-	38	-	17
	8	R255 00 178	463.08 PNF 17	NPT 3/8	-	39.5	-	19
	8	R255 00 176	463.08 PNF 21	NPT 1/2	-	44	-	24

Plug with hose barb / Nippel mit Schlauchanschluss TYPE 463.08 **rtc**

Plug / Nippel	Size / Größe	Alternative Order No Alternative Bestellnr.	Order No / Bestellnr.	Ød	Ød1	L	L1	HEX.
	8	R255 00 029	463.08 PHF 08	Ø8 - 5/16	14	50	-	-
	8	R255 00 030	463.08 PHF 10	Ø10 - 3/8	14	50	-	-
	8	R255 00 031	463.08 PHF 13	Ø13 - 1/2	16	50	-	-

Plug with plastic hose connection / Nippel mit Kunststoffschlauchanschluss TYPE 463.08 **rtc**

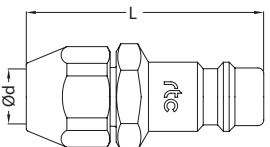
Plug / Nippel	Size / Größe	Alternative Order No Alternative Bestellnr.	Order No / Bestellnr.	Ød	Ød1	L	L1	HEX.
	8	-	463.08 PVF 0610	6.5x10	-	51	-	22
	8	-	463.08 PVF 0812	8x12	-	51	-	22
	8	-	463.08 PVF 1116	11x16	-	52.5	-	27



rtc[®]

QUICK CONNECT TECHNOLOGY
www.rtc-tec.com

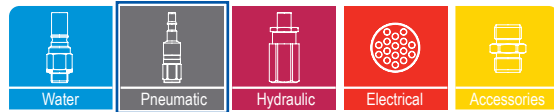

464.08

rtc TYPE





Compatible - Kompatibilität

rtc	013
Nitto Kohki	20 & 30 & 40
Cejn	315
Rectus	13

Temperature Range - Temperaturbereich

Nitrile (N)	-20°C + 110°C (- 4°F + 230°F)
FPM (V)	-20°C + 180°C (- 4°F + 356°F)
EPDM (Ethylene Propylene)	-40°C + 150°C (- 40°F + 302°F)

Working Pressure - Betriebsdruck

25 Bar (360 PSI)

Connction / Disconnection Max. Pressure -

Ein und Auskuppelbar bis Max. Druck
15 Bar (220 PSI)

Flow size - Nennweite

rtc type 464.08 8mm (3/8")

Standard version - Standardversion

Seals - Dichtung : Nitrile (N)

**Material of Standard Coupler /
Material für die Standardversion**

Body / Housing - Kupplungsgrundkörper/Gehäuse	Steel tenifer threaded Stahl teneferiert
Inner Part / Cylinder - Innenteil / Zylinder	Surface hardened steel Zinc-nickel plated Stahl gehärtet, Zink-Nickel beschichtet
Back Part - Hinterteil Sleeve -	Steel zinc plated - Stahl verzinkt Zinc diecasted, nickel plated & orange plastic coated
Hülse	Zink-Druckguss, vernickelt und orange Gummi beschichtet
Springs - Federn Seals - Dichtungen	Stainless steel - Edelstahl Nitrile (N)
Plug - Nippel	Surface Hardened Steel, Galvanized Stahl gehärtet, verzinkt

Advantages

- The system perfectly fits to the ISO 4414, EN 983 safety requirements.
- Through flow, minimum pressure loss.
- Negligible Connecting Force
- Smart and Ergonomic features
- Ease of Handling
- Optimised Size

Vorteil

- Sicherheit gemäß ISO 4414, EN 983
- Voller Durchgang, sehr geringer Druckverlust
- Einfache Bedienung, sehr geringe Kuppelkraft
- Kompakte Bauform

Aluminium Version (AL)

- Light weight 75g

Aluminum Version (AL)

- Geringes Gewicht 75g

**Material of Aluminium Coupler /
Material für die Aluminium Version**

Body / Housing - Kupplungsgrundkörper/Gehäuse	Aluminium Aluminum
Inner Part / Cylinder - Innenteil / Zylinder	Surface hardened steel Zinc-nickel plated Stahl gehärtet, Zink-Nickel Beschichtet
Back Part - Hinterteil Sleeve -	Aluminium - Aluminum Zinc diecasted, nickel plated & orange plastic coated
Hülse	Zink-Druckguss, vernickelt & orange Gummi beschichtet
Springs - Federn Seals - Dichtungen	Stainless steel - Edelstahl FPM (V)
Plug - Nippel	Surface Hardened Steel, Galvanized Stahl gehärtet, verzinkt



Flow Rate vs Pressure Drop Graph

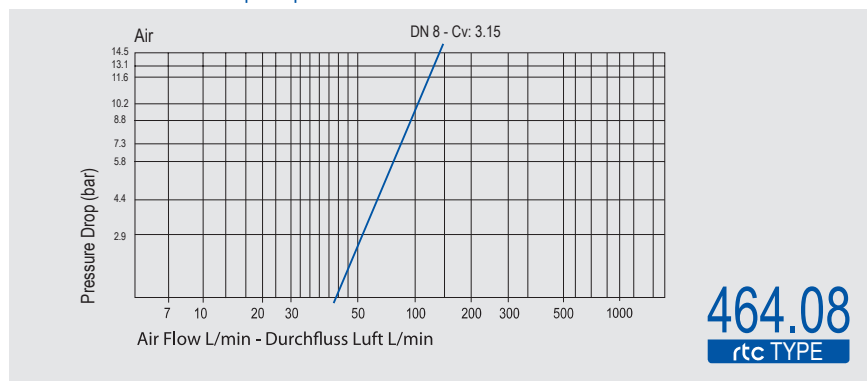

rtc TYPE 464.08

Male thread socket / Kupplung mit Aussengewinde



Socket / Kupplung

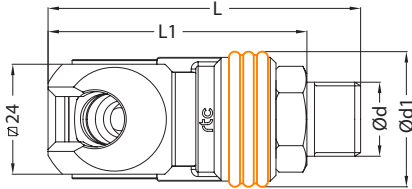

Size / Größe	Alternative Order No Alternative Bestellnr.	Order No / Bestellnr.	Ød	Ød1	L	L1	HEX.
8	R205 00 053	464.08 SMO 13	BSP 1/4	30	69.5	58.5	20
8	R205 00 021	464.08 SMO 17	BSP 3/8	30	69.5	58.5	20
8	R205 00 022	464.08 SMO 21	BSP 1/2	30	71.5	59.5	22
8	R205 00 426	464.08 STO 13	NPT 1/4	30	70.5	56.5	20
8	R205 00 037	464.08 STO 17	NPT 3/8	30	71.5	57.5	20
8	R205 00 038	464.08 STO 21	NPT 1/2	30	78.5	59.5	22
8	R205 00 063	464.08 SMO 13 AL	BSP 3/8	30	69.5	58.5	20
8	R205 00 064	464.08 SMO 17 AL	BSP 1/2	30	69.5	58.5	20
8	R205 00 065	464.08 SMO 21 AL	BSP 3/4	30	71.5	59.5	22
8	R205 00 427	464.08 STO 13 AL	NPT 3/8	30	70.5	56.5	20
8	R205 00 075	464.08 STO 17 AL	NPT 1/2	30	71.5	57.5	20
8	R205 00 076	464.08 STO 21 AL	NPT 3/4	30	78.5	59.5	22

*AL: Aluminium

rtc TYPE 464.08

Female thread socket / Kupplung mit Innengewinde



Socket / Kupplung

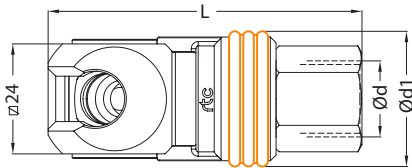

Size / Größe	Alternative Order No Alternative Bestellnr.	Order No / Bestellnr.	Ød	Ød1	L	L1	HEX.
8	R205 00 018	464.08 SFO 13	BSP 1/4	30	68.5	-	20
8	R205 00 019	464.08 SFO 17	BSP 3/8	30	68.5	-	20
8	R205 00 020	464.08 SFO 21	BSP 1/2	30	69.5	-	24
8	R205 00 034	464.08 SNO 13	NPT 1/4	30	68.5	-	20
8	R205 00 035	464.08 SNO 17	NPT 3/8	30	68.5	-	20
8	R205 00 036	464.08 SNO 21	NPT 1/2	30	69.5	-	24
8	R205 00 060	464.08 SFO 13 AL	BSP 3/8	30	68.5	-	20
8	R205 00 061	464.08 SFO 17 AL	BSP 1/2	30	68.5	-	20
8	R205 00 062	464.08 SFO 21 AL	BSP 3/4	30	69.5	-	24
8	R205 00 072	464.08 SNO 13 AL	NPT 3/8	30	68.5	-	20
8	R205 00 073	464.08 SNO 17 AL	NPT 1/2	30	68.5	-	20
8	R205 00 074	464.08 SNO 21 AL	NPT 3/4	30	69.5	-	24

*AL: Aluminium

rtc TYPE 464.08

Socket with hose barb / Kupplung mit Schlauchanschluss



Socket / Kupplung

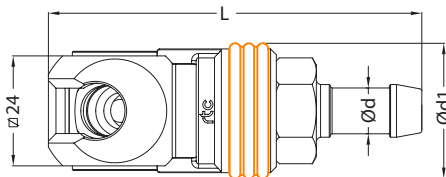

Size / Größe	Alternative Order No Alternative Bestellnr.	Order No / Bestellnr.	Ød	Ød1	L	L1	HEX.
8	R205 00 054	464.08 SHO 08	Ø8 - 5/16	30	79	-	-
8	R205 00 055	464.08 SHO 10	Ø10 - 3/8	30	79	-	-
8	R205 00 056	464.08 SHO 13	Ø13 - 1/2	30	79	-	-
8	R205 00 077	464.08 SHO 08 AL	Ø8 - 5/16	30	79	-	-
8	R205 00 078	464.08 SHO 10 AL	Ø10 - 3/8	30	79	-	-
8	R205 00 079	464.08 SHO 13 AL	Ø13 - 1/2	30	79	-	-

*AL: Aluminium

rtc TYPE 464.08

Socket with plastic hose connection / Kupplung mit Kunststoffschlauchanschluss



Socket / Kupplung

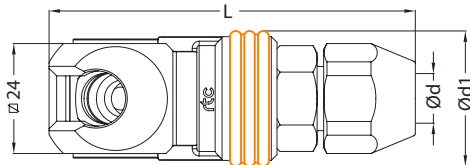

Size / Größe	Alternative Order No Alternative Bestellnr.	Order No / Bestellnr.	Ød	Ød1	L	L1	HEX.
8	R205 00 057	464.08 SVO 0610	6.5x10	30	80	-	22
8	R205 00 058	464.08 SVO 0812	8.0x12	30	80	-	22
8	R205 00 059	464.08 SVO 1116	11x16	30	84	-	27
8	R205 00 080	464.08 SVO 0610 AL	6.5x10	30	80	-	22
8	R205 00 081	464.08 SVO 0812 AL	8x12	30	80	-	22
8	R205 00 082	464.08 SVO 1116 AL	11x16	30	84	-	27

*AL: Aluminium

Plug with male thread / Nippel mit Aussengewinde TYPE 464.08 **rtc**

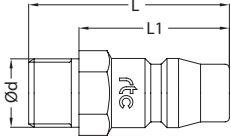
Plug / Nippel	Size / Größe	Alternative Order No Alternative Bestellnr.	Order No / Bestellnr.	Ød	Ød1	L	L1	HEX.
	8	R255 00 032	464.08 PMF 13	BSP 1/4	-	41	30	14
	8	R255 00 033	464.08 PMF 17	BSP 3/8	-	43	32	19
	8	R255 00 034	464.08 PMF 21	BSP 1/2	-	47	33	24
	8	R255 00 058	464.08 PTF 13	NPT 1/4	-	42	30	14
	8	R255 00 059	464.08 PTF 17	NPT 3/8	-	44	32	19
	8	R255 00 060	464.08 PTF 21	NPT 1/2	-	50	33	22

Plug with female thread / Nippel mit Innengewinde TYPE 464.08 **rtc**

Plug / Nippel	Size / Größe	Alternative Order No Alternative Bestellnr.	Order No / Bestellnr.	Ød	Ød1	L	L1	HEX.
	8	R255 00 035	464.08 PFF 13	BSP 1/4	-	43	-	17
	8	R255 00 036	464.08 PFF 17	BSP 3/8	-	44	-	19
	8	R255 00 037	464.08 PFF 21	BSP 1/2	-	48.5	-	27
	8	R255 00 061	464.08 PNF 13	NPT 1/4	-	43	-	17
	8	R255 00 062	464.08 PNF 17	NPT 3/8	-	44	-	22
	8	R255 00 063	464.08 PNF 21	NPT 1/2	-	49	-	27

Plug with hose barb / Nippel mit Schlauchanschluss TYPE 464.08 **rtc**

Plug / Nippel	Size / Größe	Alternative Order No Alternative Bestellnr.	Order No / Bestellnr.	Ød	Ød1	L	L1	HEX.
	8	R255 00 038	464.08 PHF 08	Ø8 - 5/16	14	51	-	-
	8	R255 00 039	464.08 PHF 10	Ø10 - 3/8	14	51	-	-
	8	R255 00 040	464.08 PHF 13	Ø13 - 1/2	16	51	-	-

Plug with plastic hose connection / Nippel mit Kunststoffschlauchanschluss TYPE 464.08 **rtc**

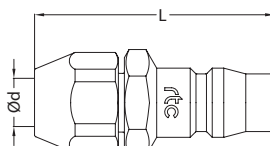
Plug / Nippel	Size / Größe	Alternative Order No Alternative Bestellnr.	Order No / Bestellnr.	Ød	Ød1	L	L1	HEX.
	8	-	464.08 PVF 0610	6.5x10	-	52	-	22
	8	-	464.08 PVF 0812	8x12	-	52	-	22
	8	-	464.08 PVF 1116	11x16	-	56	-	27



rtc[®]

QUICK CONNECT TECHNOLOGY
www.rtc-tec.com

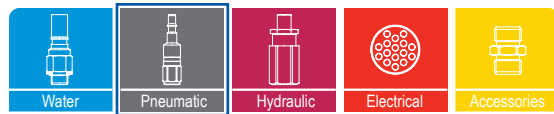

465.08

rtc TYPE





Compatible - Kompatibilität

rtc	095
rtc	096 (Coupling Only)
Cejn	342 (Coupling Only)
Cejn	344
Rectus	95KS
Rectus	96KS (Coupling Only)

Temperature Range - Temperaturbereich

Nitrile (N)	-20°C + 110°C (- 4°F + 230°F)
FPM (V)	-20°C + 180°C (- 4°F + 356°F)
EPDM (Ethylene Propylene)	-40°C + 150°C (- 40°F + 302°F)

Working Pressure - Betriebsdruck

25 Bar (360 PSI)

Connction / Disconnection Max. Pressure -

Ein und Auskuppelbar bis Max. Druck

15 Bar (220 PSI)

Flow size - Nennweite

rtc type 465.08 7.8mm (3/8")

Standard version - Standardversion

Seals - Dichtung : Nitrile (N)

Material of Standard Coupler / Material für die Standardversion

Body / Housing - Kupplungsgrundkörper/Gehäuse	Brass chrome plated - Messing verchromt
Inner Part / Cylinder - Innenteil / Zylinder	Brass chrome plated - Messing verchromt
Back Part - Hinterteil	Brass chrome plated - Messing verchromt
Sleeve - Hülse	Zinc diecasted, nickel plated & orange plastic coated Zink-Druckguss, vernickelt und orange Gummi beschichtet
Springs - Federn	Stainless steel - Edelstahl
Seals - Dichtungen	FPM (V)
Plug - Nippel	Brass, chrome plated Messing, verchromt

Advantages

- The system perfectly fits to the **ISO 4414, EN 983** safety requirements.
- Through flow, minimum pressure loss.
- Negligible Connecting Force
- Smart and Ergonomic features
- Ease of Handling
- Optimised Size

Vorteil

- Sicherheit gemäß **ISO 4414, EN 983**
- Voller Durchgang, sehr geringer Druckverlust
- Einfache Bedienung, sehr geringe Kuppelkraft
- Kompakte Bauform



Flow Rate vs Pressure Drop Graph

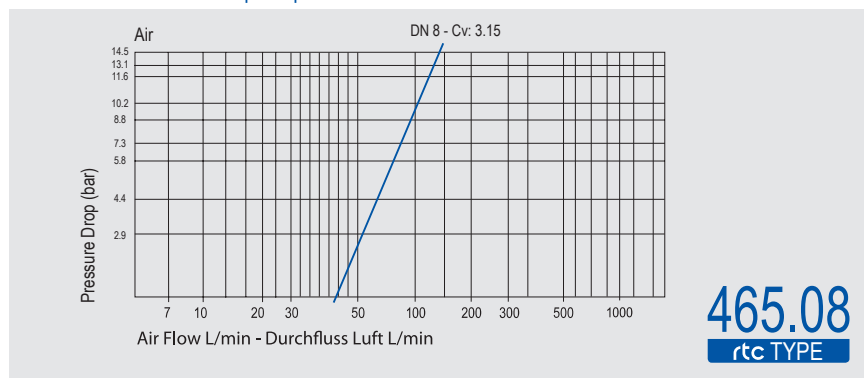

465.08
rtc TYPE

rtc TYPE 465.08

Male thread socket / Kupplung mit Aussengewinde



Socket / Kupplung

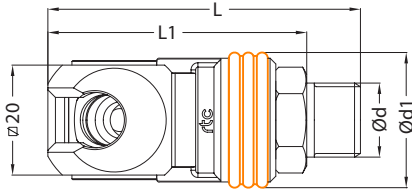

Size / Größe	Alternative Order No Alternative Bestellnr.	Order No / Bestellnr.	Ød	Ød1	L	L1	HEX.
8	R205 00 739	465.08 SMO 13	BSP 1/4	25	59.5	48.5	19
8	R205 00 717	465.08 SMO 17	BSP 3/8	25	59.5	48.5	19
8	-	465.08 SMO 21	BSP 1/2	25	61.5	49.5	22
8	R205 00 740	465.08 STO 13	NPT 1/4	25	60.5	48.5	19
8	R205 00 699	465.08 STO 17	NPT 3/8	25	62.5	48.5	19
8	-	465.08 STO 21	NPT 1/2	25	68.5	49.5	22

rtc TYPE 465.08

Female thread socket / Kupplung mit Innengewinde



Socket / Kupplung

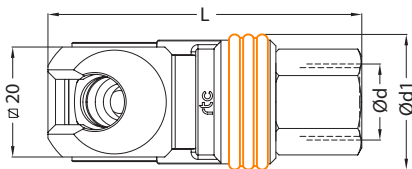

Size / Größe	Alternative Order No Alternative Bestellnr.	Order No / Bestellnr.	Ød	Ød1	L	L1	HEX.
8	R205 00 738	465.08 SFO 13	BSP 1/4	25	56.5	-	19
8	R205 00 691	465.08 SFO 17	BSP 3/8	25	58.5	-	19
8	-	465.08 SFO 21	BSP 1/2	25	60.5	-	24
8	R205 00 696	465.08 SNO 13	NPT 1/4	25	57.5	-	19
8	R205 00 697	465.08 SNO 17	NPT 3/8	25	59.5	-	20
8	-	465.08 SNO 21	NPT 1/2	25	65.5	-	24

rtc TYPE 465.08

Socket with hose barb / Kupplung mit Schlauchanschluss



Socket / Kupplung

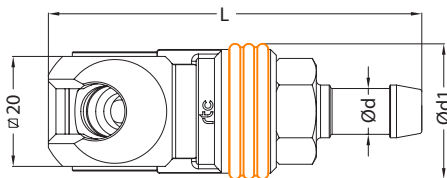

Size / Größe	Alternative Order No Alternative Bestellnr.	Order No / Bestellnr.	Ød	Ød1	L	L1	HEX.
8	R205 00 741	465.08 SHO 06	Ø6 - 1/4	25	69	-	-
8	R205 00 671	465.08 SHO 08	Ø8 - 5/16	25	69	-	-
8	R205 00 698	465.08 SHO 10	Ø10 - 3/8	25	69	-	-
8	R205 00 742	465.08 SHO 13	Ø13 - 1/2	25	69	-	-

Plug with male thread / Nippel mit Aussengewinde TYPE 465.08 **rtc**

Plug / Nippel	Size / Größe	Alternative Order No Alternative Bestellnr.	Order No / Bestellnr.	Ød	Ød1	L	L1	HEX.
	8	R255 00 420	465.08 PMF 13	BSP 1/4	-	42	31	14
	8	R255 00 421	465.08 PMF 17	BSP 3/8	-	43.5	32.5	19
	8	R255 00 422	465.08 PMF 21	BSP 1/2	-	48	35	22
	8	R255 00 433	465.08 PTF 13	NPT 1/4	-	43	31	14
	8	R255 00 434	465.08 PTF 17	NPT 3/8	-	44.5	32.5	17
	8	-	465.08 PTF 21	NPT 1/2	-	52	35	22

Plug with female thread / Nippel mit Innengewinde TYPE 465.08 **rtc**

Plug / Nippel	Size / Größe	Alternative Order No Alternative Bestellnr.	Order No / Bestellnr.	Ød	Ød1	L	L1	HEX.
	8	R255 00 423	465.08 PFF 13	BSP 1/4	-	43	-	17
	8	R255 00 424	465.08 PFF 17	BSP 3/8	-	44	-	19
	8	R255 00 425	465.08 PFF 21	BSP 1/2	-	48	-	24
	8	R255 00 435	465.08 PNF 13	NPT 1/4	-	43	-	17
	8	R255 00 430	465.08 PNF 17	NPT 3/8	-	44.5	-	19
	8	-	465.08 PNF 21	NPT 1/2	-	49	-	24

Plug with hose barb / Nippel mit Schlauchanschluss TYPE 465.08 **rtc**

Plug / Nippel	Size / Grosse	Alternative Order No Alternative Bestellnr.	Order No / Bestellnr.	Ød	Ød1	L	L1	HEX.
	8	R255 00 426	465.08 PHF 06	Ø6 - 1/4	14	55	-	-
	8	R255 00 418	465.08 PHF 08	Ø8 - 5/16	14	55	-	-
	8	R255 00 427	465.08 PHF 10	Ø10 - 3/8	14	55	-	-
	8	R255 00 428	465.08 PHF 13	Ø13 - 1/2	16	55	-	-

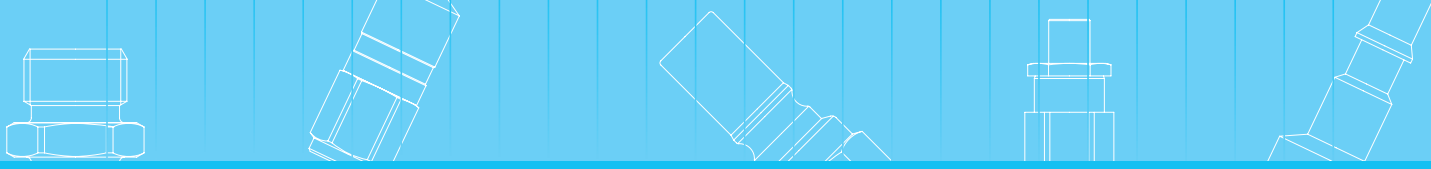

rtc[®]

QUICK CONNECT TECHNOLOGY
www.rtc-tec.com

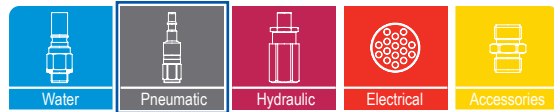

466.06

rtc TYPE





Compatible - Kompatibilität

rtc	019
PCL	AC21 & AC29 & AC91
Rectus	19

Temperature Range - Temperaturbereich

Nitrile (N)	-20°C + 110°C (- 4°F + 230°F)
FPM (V)	-20°C + 180°C (- 4°F + 356°F)
EPDM (Ethylene Propylene)	-40°C + 150°C (- 40°F + 302°F)

Working Pressure - Betriebsdruck

25 Bar (360 PSI)

Connction / Disconnection Max. Pressure -

Ein- und Auskuppelbar bis Max. Druck

15 Bar (220 PSI)

Flow size - Nennweite

rtc type 466.06 6mm (1/4")

Standard version - Standardversion

Seals - Dichtung : Nitrile (N)

Material of Standard Coupler / Material für die Standardversion

Body / Housing -	Steel tenifer threated
Kupplungsgrundkörper/Gehäuse	Stahl teneferiert
Inner Part / Cylinder -	Surface hardened steel
	Zinc-nickel plated
Innenteil / Zylinder	Stahl gehärtet, Zink-Nickel beschichtet
Back Part - Hinterteil	Steel zinc plated - Stahl verzinkt
Sleeve -	Zinc diecasted, nickel plated & orange plastic coated
Hülse	Zink-Druckguss, vernickelt und orange Gummi beschichtet
Springs - Federn	Stainless steel - Edelstahl
Seals - Dichtungen	Nitrile (N)
Plug -	Surface Hardened Steel, Galvanized
Nippel	Stahl gehärtet, verzinkt

Advantages

- The system perfectly fits to the **ISO 4414, EN 983** safety requirements.
- Through flow, minimum pressure loss.
- Negligible Connecting Force
- Smart and Ergonomic features
- Ease of Handling
- Optimised Size

Vorteil

- Sicherheit gemäß **ISO 4414, EN 983**
- Voller Durchgang, sehr geringer Druckverlust
- Einfache Bedienung, sehr geringe Kuppelkraft
- Kompakte Bauform



Flow Rate vs Pressure Drop Graph

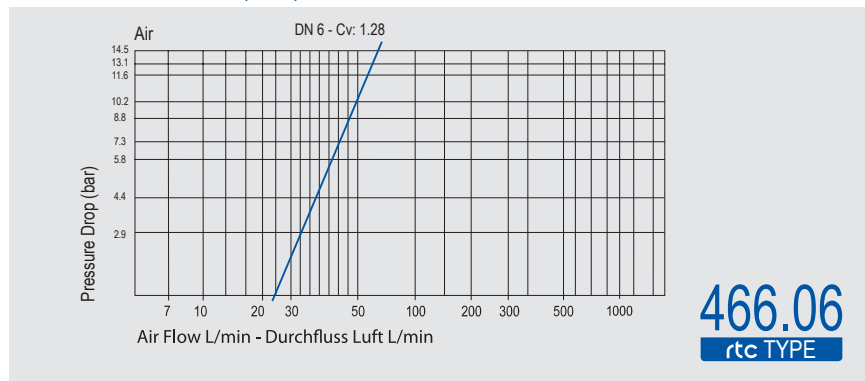

466.06
rtc TYPE

rtc TYPE 466.06

Male thread socket / Kupplung mit Aussengewinde



Socket / Kupplung

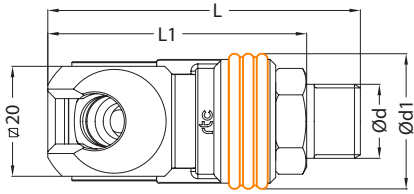

Size / Größe	Alternative Order No Alternative Bestellnr.	Order No / Bestellnr.	Ød	Ød1	L	L1	HEX.
6	R205 00 434	466.06 SMO 13	BSP 1/4	25	59.5	48.5	19
6	R205 00 441	466.06 SMO 17	BSP 3/8	25	59.5	48.5	19
6	R205 00 442	466.06 SMO 21	BSP 1/2	25	61.5	49.5	22
6	-	466.06 STO 13	NPT 1/4	25	60.5	48.5	19
6	-	466.06 STO 17	NPT 3/8	25	62.5	48.5	19
6	-	466.06 STO 21	NPT 1/2	25	68.5	49.5	22

rtc TYPE 466.06

Female thread socket / Kupplung mit Innengewinde



Socket / Kupplung

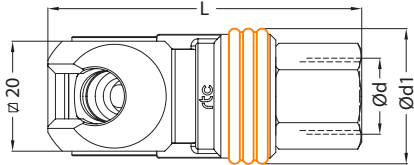

Size / Größe	Alternative Order No Alternative Bestellnr.	Order No / Bestellnr.	Ød	Ød1	L	L1	HEX.
6	R205 00 438	466.06 SFO 13	BSP 1/4	25	56.5	-	19
6	R205 00 439	466.06 SFO 17	BSP 3/8	25	58.5	-	19
6	R205 00 440	466.06 SFO 21	BSP 1/2	25	60.5	-	24
6	-	466.06 SNO 13	NPT 1/4	25	57.5	-	19
6	-	466.06 SNO 17	NPT 3/8	25	59.5	-	20
6	-	466.06 SNO 21	NPT 1/2	25	65.5	-	24

rtc TYPE 466.06

Socket with hose barb / Kupplung mit Schlauchanschluss



Socket / Kupplung

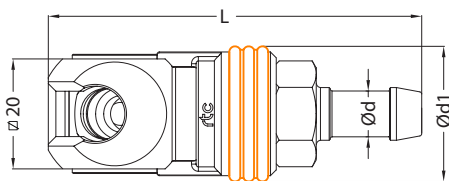

Size / Größe	Alternative Order No Alternative Bestellnr.	Order No / Bestellnr.	Ød	Ød1	L	L1	HEX.
6	R205 00 443	466.06 SHO 06	Ø6 - 1/4	25	69	-	-
6	R205 00 444	466.06 SHO 08	Ø8 - 5/16	25	69	-	-
6	R205 00 445	466.06 SHO 10	Ø10 - 3/8	25	69	-	-

rtc TYPE 466.06

Socket with plastic hose connection / Kupplung mit Kunststoffschlauchanschluss



Socket / Kupplung

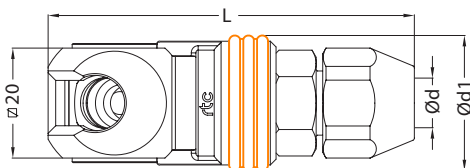

Size / Größe	Alternative Order No Alternative Bestellnr.	Order No / Bestellnr.	Ød	Ød1	L	L1	HEX.
6	-	466.06 SVO 0610	6.5x10	25	70	-	22
6	-	466.06 SVO 0812	8x12	25	70	-	22

Plug with male thread / Nippel mit Aussengewinde TYPE 466.06 **rtc**

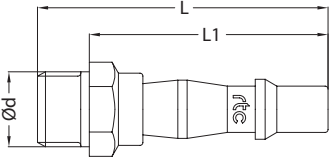
Plug / Nippel	Size / Größe	Alternative Order No Alternative Bestellnr.	Order No / Bestellnr.	Ød	Ød1	L	L1	HEX.
	6	-	466.06 PMF 10	BSP 1/8	-	49	41	14
	6	R255 00 320	466.06 PMF 13	BSP 1/4	-	53	42	14
	6	R255 00 321	466.06 PMF 17	BSP 3/8	-	55.5	44.5	17

Plug with female thread / Nippel mit Innengewinde TYPE 466.06 **rtc**

Plug / Nippel	Size / Größe	Alternative Order No Alternative Bestellnr.	Order No / Bestellnr.	Ød	Ød1	L	L1	HEX.
	6	-	466.06 PFF 10	BSP 1/8	-	49	-	14
	6	R255 00 318	466.06 PFF 13	BSP 1/4	-	55	-	17
	6	R255 00 319	466.06 PFF 17	BSP 3/8	-	57.5	-	19

Plug with hose barb / Nippel mit Schlauchanschluss TYPE 466.06 **rtc**

Plug / Nippel	Size / Größe	Alternative Order No Alternative Bestellnr.	Order No / Bestellnr.	Ød	Ød1	L	L1	HEX.
	6	R255 00 322	466.06 PHF 06	Ø6 - 1/4	14	63	-	-
	6	R255 00 323	466.06 PHF 08	Ø8 - 5/16	14	63	-	-
	6	R255 00 324	466.06 PHF 10	Ø10 - 3/8	14	63	-	-



rtc[®]

QUICK CONNECT TECHNOLOGY
www.rtc-tec.com

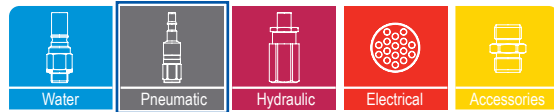

467.06

rtc TYPE





Compatible - Kompatibilität

Imopac CD25, -S, -N

Temperature Range - Temperaturbereich

Nitrile (N) -20°C + 110°C (- 4°F + 230°F)
 FPM (V) -20°C + 180°C (- 4°F + 356°F)
 EPDM (Ethylene Propylene) -40°C + 150°C (- 40°F + 302°F)

Working Pressure - Betriebsdruck

25 Bar (360 PSI)

Connction / Disconnection Max. Pressure -

Ein- und Auskuppelbar bis Max. Druck
 15 Bar (220 PSI)

Flow size - Nennweite

rtc type 467.06 5.5mm (1/4")

Standard version - Standardversion

Seals - Dichtung : Nitrile (N)

Material of Standard Coupler / Material für die Standardversion

Body / Housing - Kupplungsgrundkörper/Gehäuse	Steel tenifer threaded Stahl teneferiert
Inner Part / Cylinder - Innenteil / Zylinder	Surface hardened steel Zinc-nickel plated Stahl gehärtet, Zink-Nickel beschichtet
Back Part - Hinterteil Sleeve -	Steel zinc plated - Stahl verzinkt Zinc diecasted, nickel plated & orange plastic coated
Hülse	Zink-Druckguss, vernickelt und orange Gummi beschichtet
Springs - Federn	Stainless steel - Edelstahl
Seals - Dichtungen	Nitrile (N)
Plug -	Surface Hardened Steel, Galvanized
Nippel	Stahl gehärtet, verzinkt

Advantages

- The system perfectly fits to the ISO 4414, EN 983 safety requirements.
- Through flow, minimum pressure loss.
- Negligible Connecting Force
- Smart and Ergonomic features
- Ease of Handling
- Optimised Size

Vorteil

- Sicherheit gemäß ISO 4414, EN 983
- Voller Durchgang, sehr geringer Druckverlust
- Einfache Bedienung, sehr geringe Kuppelkraft
- Kompakte Bauform

Flow Rate vs Pressure Drop Graph

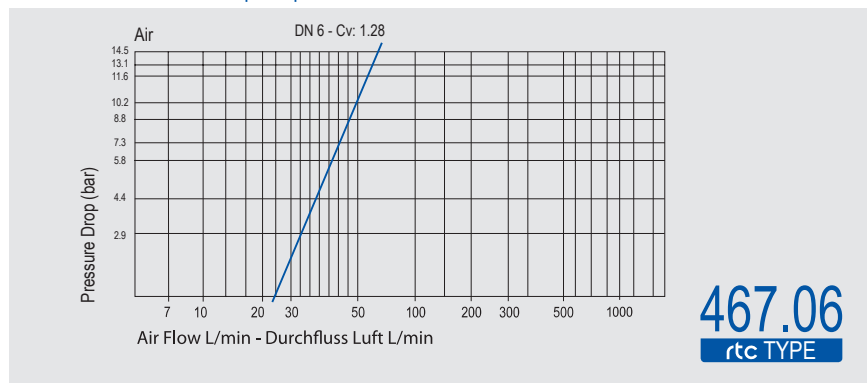

rtc TYPE 467.06

Male thread socket / Kupplung mit Aussengewinde



Socket / Kupplung

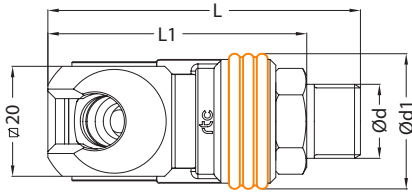

Size / Größe	Alternative Order No Alternative Bestellnr.	Order No / Bestellnr.	Ød	Ød1	L	L1	HEX.
6	R205 00 729	467.06 SMO 13	BSP 1/4	25	59.5	48.5	19
6	R205 00 730	467.06 SMO 17	BSP 3/8	25	59.5	48.5	19
6	R205 00 731	467.06 SMO 21	BSP 1/2	25	61.5	49.5	22
6	-	467.06 STO 13	NPT 1/4	25	60.5	48.5	19
6	-	467.06 STO 17	NPT 3/8	25	62.5	48.5	19
6	-	467.06 STO 21	NPT 1/2	25	68.5	49.5	22

rtc TYPE 467.06

Female thread socket / Kupplung mit Innengewinde



Socket / Kupplung

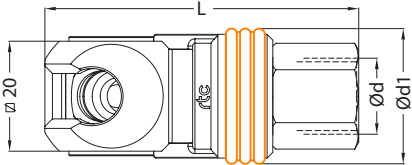

Size / Größe	Alternative Order No Alternative Bestellnr.	Order No / Bestellnr.	Ød	Ød1	L	L1	HEX.
6	R205 00 726	467.06 SFO 13	BSP 1/4	25	56.5	-	19
6	R205 00 727	467.06 SFO 17	BSP 3/8	25	58.5	-	19
6	R205 00 728	467.06 SFO 21	BSP 1/2	25	60.5	-	24
6	-	467.06 SNO 13	NPT 1/4	25	57.5	-	19
6	-	467.06 SNO 17	NPT 3/8	25	59.5	-	20
6	-	467.06 SNO 21	NPT 1/2	25	65.5	-	24

rtc TYPE 467.06

Socket with hose barb / Kupplung mit Schlauchanschluss



Socket / Kupplung

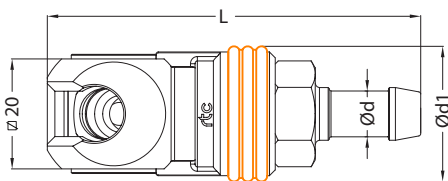

Size / Größe	Alternative Order No Alternative Bestellnr.	Order No / Bestellnr.	Ød	Ød1	L	L1	HEX.
6	R205 00 732	467.06 SHO 06	Ø6 - 1/4	25	69	-	-
6	R205 00 733	467.06 SHO 08	Ø8 - 5/16	25	69	-	-
6	R205 00 734	467.06 SHO 10	Ø10 - 3/8	25	69	-	-

rtc TYPE 467.06

Socket with plastic hose connection / Kupplung mit Kunststoffschlauchanschluss



Socket / Kupplung

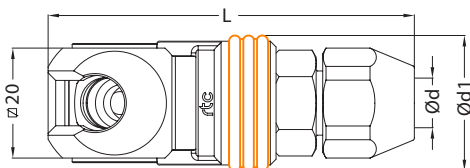

Size / Größe	Alternative Order No Alternative Bestellnr.	Order No / Bestellnr.	Ød	Ød1	L	L1	HEX.
6	R205 00 735	467.06 SVO 0610	6.5x10	25	70	-	22
6	R205 00 736	467.06 SVO 0812	8x12	25	70	-	22



Plug with male thread / Nippel mit Aussengewinde

TYPE 467.06 **rtc**

Plug / Nippel	Size / Größe	Alternative Order No Alternative Bestellnr.	Order No / Bestellnr.	Ød	Ød1	L	L1	HEX.
	6	-	467.06 PMF 13	BSP 1/4	-	41	30	14
	6	-	467.06 PMF 17	BSP 3/8	-	42	30	17



Plug with female thread / Nippel mit Innengewinde

TYPE 467.06 **rtc**

Plug / Nippel	Size / Größe	Alternative Order No Alternative Bestellnr.	Order No / Bestellnr.	Ød	Ød1	L	L1	HEX.
	6	-	467.06 PFF 13	BSP 1/4	-	40	-	17
	6	-	467.06 PFF 17	BSP 3/8	-	42	-	20



Plug with hose barb / Nippel mit Schlauchanschluss

TYPE 467.06 **rtc**

Plug / Nippel	Size / Größe	Alternative Order No Alternative Bestellnr.	Order No / Bestellnr.	Ød	Ød1	L	L1	HEX.
	6	-	467.06 PHF 08	Ø8 - 5/16	14	47	-	-
	6	-	467.06 PHF 10	Ø10 - 3/8	14	52	-	-



rtc[®]

QUICK CONNECT TECHNOLOGY
www.rtc-tec.com

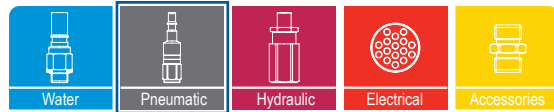

468.08

rtc TYPE





Compatible - Kompatibilität

rtc	033
Rectus	33
Atlas Copco	QIC10

Temperature Range - Temperaturbereich

Nitrile (N)	-20°C + 110°C (- 4°F + 230°F)
FPM (V)	-20°C + 180°C (- 4°F + 356°F)
EPDM (Ethylene Propylene)	-40°C + 150°C (- 40°F + 302°F)

Working Pressure - Betriebsdruck

25 Bar (360 PSI)

Connction / Disconnection Max. Pressure -

Ein- und Auskuppelbar bis Max. Druck
15 Bar (220 PSI)

Flow size - Nennweite

rtc type 468.08 8mm (3/8")

Standard version - Standardversion

Seals - Dichtung : Nitrile (N)

Material of Standard Coupler / Material für die Standardversion

Body / Housing -	Steel tenifer threaded
Kupplungsgrundkörper/Gehäuse	Stahl teneferiert
Inner Part / Cylinder -	Surface hardened steel Zinc-nickel plated
Innenteil / Zylinder	Stahl gehärtet, Zink-Nickel beschichtet
Back Part - Hinterteil	Steel zinc plated - Stahl verzinkt
Sleeve -	Zinc diecasted, nickel plated & orange plastic coated
Hülse	Zink-Druckguss, vernickelt und orange Gummi beschichtet
Springs - Federn	Stainless steel - Edelstahl
Seals - Dichtungen	Nitrile (N)
Plug -	Surface Hardened Steel, Galvanized
Nippel	Stahl gehärtet, verzinkt

Advantages

- The system perfectly fits to the ISO 4414, EN 983 safety requirements.
- Through flow, minimum pressure loss.
- Negligible Connecting Force
- Smart and Ergonomic features
- Ease of Handling
- Optimised Size

Vorteil

- Sicherheit gemäß ISO 4414, EN 983
- Voller Durchgang, sehr geringer Druckverlust
- Einfache Bedienung, sehr geringe Kuppelkraft
- Kompakte Bauform



Flow Rate vs Pressure Drop Graph

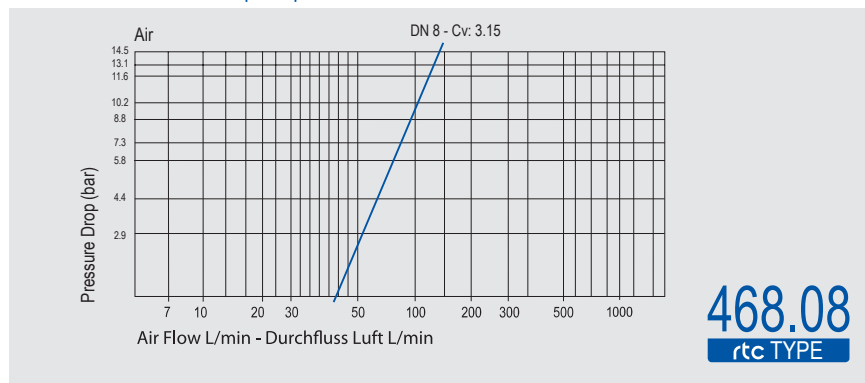

rtc TYPE 468.08

Male thread socket / Kupplung mit Aussengewinde



Socket / Kupplung

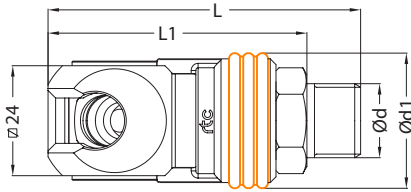

Size / Größe	Alternative Order No Alternative Bestellnr.	Order No / Bestellnr.	Ød	Ød1	L	L1	HEX.
8	-	468.08 SMO 13	BSP 1/4	30	69.5	58.5	20
8	-	468.08 SMO 17	BSP 3/8	30	69.5	58.5	20
8	-	468.08 SMO 21	BSP 1/2	30	71.5	59.5	22
8	-	468.08 STO 13	NPT 1/4	30	70.5	56.5	20
8	-	468.08 STO 17	NPT 3/8	30	71.5	57.5	20
8	-	468.08 STO 21	NPT 1/2	30	78.5	59.5	22

rtc TYPE 468.08

Female thread socket / Kupplung mit Innengewinde



Socket / Kupplung

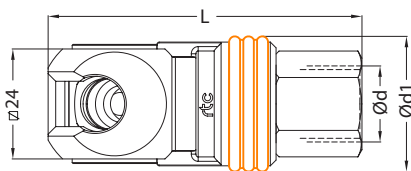

Size / Größe	Alternative Order No Alternative Bestellnr.	Order No / Bestellnr.	Ød	Ød1	L	L1	HEX.
8	-	468.08 SFO 13	BSP 1/4	30	68.5	-	20
8	-	468.08 SFO 17	BSP 3/8	30	68.5	-	20
8	-	468.08 SFO 21	BSP 1/2	30	69.5	-	24
8	-	468.08 SNO 13	NPT 1/4	30	68.5	-	20
8	-	468.08 SNO 17	NPT 3/8	30	68.5	-	20
8	-	468.08 SNO 21	NPT 1/2	30	69.5	-	24

rtc TYPE 468.08

Socket with hose barb / Kupplung mit Schlauchanschluss



Socket / Kupplung

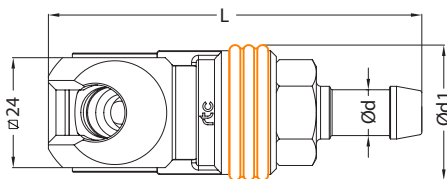

Size / Größe	Alternative Order No Alternative Bestellnr.	Order No / Bestellnr.	Ød	Ød1	L	L1	HEX.
8	-	468.08 SHO 06	Ø6 - 1/4	30	79	-	-
8	-	468.08 SHO 08	Ø8 - 5/16	30	79	-	-
8	-	468.08 SHO 10	Ø10 - 3/8	30	79	-	-
8	-	468.08 SHO 13	Ø13 - 1/2	30	79	-	-

rtc TYPE 468.08

Socket with plastic hose connection / Kupplung mit Kunststoffschlauchanschluss



Socket / Kupplung

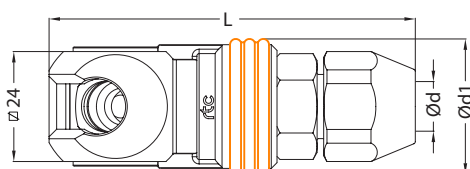

Size / Größe	Alternative Order No Alternative Bestellnr.	Order No / Bestellnr.	Ød	Ød1	L	L1	HEX.
8	-	468.08 SVO 0610	6.5x10	30	80	-	22
8	-	468.08 SVO 0812	8x12	30	80	-	22
8	-	468.08 SVO 1116	11x16	30	84	-	27

Plug with male thread / Nippel mit Aussengewinde TYPE 468.08 **rtc**

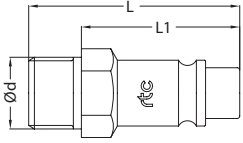
Plug / Nippel	Size / Größe	Alternative Order No Alternative Bestellnr.	Order No / Bestellnr.	Ød	Ød1	L	L1	HEX.
	8	-	468.08 PRF 13	BSPT 1/4	-	41.5	29.5	14
	8	-	468.08 PRF 17	BSPT 3/8	-	43	31	19
	8	-	468.08 PRF 21	BSPT 1/2	-	50.5	33.5	22

Plug with female thread / Nippel mit Innengewinde TYPE 468.08 **rtc**

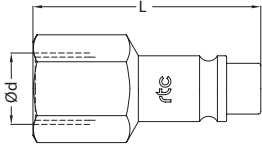
Plug / Nippel	Size / Größe	Alternative Order No Alternative Bestellnr.	Order No / Bestellnr.	Ød	Ød1	L	L1	HEX.
	8	-	468.08 PFF 13	BSP 1/4	-	41.5	-	17
	8	-	468.08 PFF 17	BSP 3/8	-	43	-	19
	8	-	468.08 PFF 21	BSP 1/2	-	47	-	24

Plug with hose barb / Nippel mit Schlauchanschluss TYPE 468.08 **rtc**

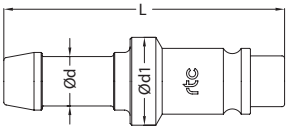
Plug / Nippel	Size / Größe	Alternative Order No Alternative Bestellnr.	Order No / Bestellnr.	Ød	Ød1	L	L1	HEX.
	8	-	468.08 PHF 06	Ø6 - 1/4	14	50	-	-
	8	-	468.08 PHF 08	Ø8 - 5/16	14	53	-	-
	8	-	468.08 PHF 10	Ø10 - 3/8	16	53	-	-
	8	-	468.08 PHF 13	Ø13 - 1/2	16	53	-	-

Plug with plastic hose connection / Nippel mit Kunststoffschluss TYPE 468.08 **rtc**

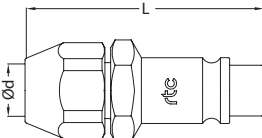
Plug / Nippel	Size / Grosse	Alternative Order No Alternative Bestellnr.	Order No / Bestellnr.	Ød	Ød1	L	L1	HEX.
	8	-	468.08 PVF 0610	6.5x10	-	56	-	22
	8	-	468.08 PVF 0812	8x12	-	56	-	22

rtc TYPE HPC

Coupling head protective cover - Schutzhauben für Schwenkkupplungen



Suitable for series Geeignet für Serien	Alternative Order No Alternative Bestellnr.	Order No / Bestellnr.	☑
462.06 / 460.06 / 461.06 / 465.08 / 466.06 / 467.06	R295 00 385	HPC 0620	20
463.08 / 464.08 / 460.08 / 461.08	R295 00 340	HPC 0825	25
460.11 / 461.11	R295 00 531	HPC 1130	30



Material: Polyamide
Werkstoff: Polyamid



rtc TYPE BPC

Coupling body protective cover - Schutzhülsen für Schwenkkupplungen



Suitable for series Geeignet für Serien	Alternative Order No Alternative Bestellnr.	Order No / Bestellnr.	☑
462.06 / 460.06 / 461.06 / 465.08 / 466.06 / 467.06	R295 00 480	BPC 0620	20
463.08 / 464.08 / 460.08 / 461.08	R295 00 481	BPC 0825	25
460.11 / 461.11	R295 00 482	BPC 1130	30



Material: Vinyl
Werkstoff: Vinyl



rtc TYPE HGS

Plastic hose protective spiral guard - Knickschutz für Spiralschlauch



Alternative Order No Alternative Bestellnr.	Order No / Bestellnr.	Ød
-	HGS 0610	6.5x10
R295 00 337	HGS 0812	8x12
R295 00 401	HGS 1116	11x16



Material: Polyamide
Werkstoff: Polyamid





rtc[®]

QUICK CONNECT TECHNOLOGY

www.rtc-tec.com



RTC TEC Bağlantı Elemanları A.Ş.

İTOSB, 9. Cadde No. 8
34539 Tepeören / Tuzla / İstanbul
TURKEY

Tel: +90 216 593 47 82
Fax: +90 216 593 47 85
info@rtc-tec.com
www.rtc-tec.com



RTC Couplings GmbH

Jahnstrasse 86
73037 Göppingen
GERMANY

Tel: +49 7161 98796-50
Fax: +49 7161 98796-79
mail@rtc-couplings.com
www.rtc-couplings.com



RTC Couplings North America

60 Meg Drive.
London, On. N6E 3T6
CANADA

Tel: +1 519 204 8334
Fax: +1 519 518 6047
tony@rtc-northamerica.com
www.rtc-northamerica.com